

ANNEX B

Amasra Hard Coal Production Project Report by SRK, October 2013



AMASRA HARDCOAL PRODUCTION PROJECT

**PREPARED BY
AMASRA HARDCOAL PROJECT GROUP
October 2013**

CONTENTS

TABLE LIST	6
FIGURES LIST.....	8
GRAPH LIST	9
APPENDIX LIST	10
1. GEOLOGY	12
1.1. GENERAL GEOLOGY OF THE FIELD.....	12
1.1.1. Palaeozoic.....	12
1.1.1.1. Carboniferous.....	12
1.1.1.1.1. Yılanlı Formation (Devonian - Visean)	12
1.1.1.1.2. Alacağzı Formation (Namurian).....	12
1.1.1.1.3. Kozlu - Karadon Formations (Westphalian)	13
1.1.1.2. Aritdere Formation.....	14
1.1.2. Mesozoic.....	14
1.4.2.1. Lower Cretaceous.....	14
1.1.2.1.1. Gümü Formation	14
1.1.2.1.2. Amasra Formation.....	15
1.4.2.2. Upper Cretaceous.....	15
1.1.2.2.1. Ahatlar Formation	15
1.1.2.2.2. Askersuyu Formation	16
1.1.2.2.3. Igneous Rocks	16
1.1.2.2.4. Alaplı Formation	17
1.1.3. Senozoic.....	18
2.1. Quaternary	18
2.2. REGIONAL GEOLOGY OF THE FIELD.....	18
2.3. OCCURING OF THE REGIONAL GEOLOGY OF THE FIELD.....	19
2.4. STRUCTURAL GEOLOGY	20
1.4.1. Folds	20
1.4.1.1. Folds That Have Been Fold By Hercynian Orogeny	20
1.4.1.1.1. Gavurpınar Syncline.....	20
1.4.1.1.2. Dıştaşlık Anticlinal.....	20
1.4.1.1.3. Amasra - Tarlağzı Basın	20
1.4.1.2. Folds That Have Been Formed By Alpine Orogeny.....	21
1.4.1.2.1. Uğurlar Anticlinal	21
1.4.1.2.2. Kazpınar Syncline	21
1.4.2. Faults	21
1.4.2.1. Surface Faults	21
1.4.2.2. Mantled Faults	21
1.4.2.3. Orogeny And Phases	22
1.5. RESOURCE AND RESERVE STUDIES.....	22
1.6. CHEMICAL ANALYSIS OF COALS IN LICENSE FIELD	23
1.7. DRILLING WORKS.....	26

2.	UNDERGROUND MAJOR DEVELOPMENTS AND PLANNING.....	28
2.1.	HOIST SHAFTS.....	28
2.1.1.	EXCAVATION-CONCRETE COMPARISON AT SHAFTS	28
2.1.2.	SHAFT SECTIONS.....	28
2.1.3.	INSETS.....	31
2.1.4.	SHAFT STATIONS.....	31
2.1.4.1.	SHAFT STATION OF SHAFT NO.1	31
2.1.4.2.	SHAFT STATION OF SHAFT NO.2	32
2.1.4.3.	SHAFT STATION OF SHAFT NO.3	32
2.1.5.	HOISTING CAPACITIES OF SHAFTS.....	33
2.2.	GALLERIES.....	39
2.2.1.	MAIN ROADWAYS OF EAST PRODUCTION BLOCK.....	39
2.2.2.	GALLERIES OF WEST PRODUCTION BLOCK.....	40
2.2.3.	GALLERIES OF SOUTHEAST PRODUCTION BLOCK	40
2.2.4.	MAIN ROADWAY LEVELS	41
2.2.5.	MAIN ROADWAYS.....	41
2.2.6.	GALLERY CROSS SECTIONS	42
2.3.	CROSS CUT GALLERIES AND INTERVALS	42
2.4.	DEVELOPMENT TIMELINES OF SHAFTS AND GALLERIES	42
2.5.	GATEWAYS CROSS SECTIONS	42
2.6.	GEOTECHNICAL ANALYSIS OF MINE AREA	42
2.6.1.	SEISMICITY OF BARTIN - AMASRA.....	42
2.6.2.	ROCK STABILITY INDEX	47
2.6.3.	SUPPORT LOAD.....	47
2.6.4.	TH SUPPORT SYSTEM	47
2.6.5.	SHOTCRETE SUPPORT SYSTEM.....	48
2.6.6.	SUPPORT CHOICE OF MAIN ROADWAYS.....	49
2.6.7.	SUPPORT TYPE COMBINATIONS.....	51
2.6.8.	SUPPORT STANDARDIZATION	53
2.6.9.	GATEWAY SUPPORT STUDY.....	53
2.6.10.	SUPPORT CHOICE OF GATEWAYS.....	54
2.6.11.	ROOF LOAD CALCULATIONS AT PRODUCTION FACE.....	54
2.6.11.1.	SUPPORT DENSITY	54
2.6.11.2.	YIELD LOAD	55
2.6.11.3.	SAFE LOAD	55

3. PRODUCTION.....	57
3.1. PLANNING OF UNDERGROUND PRODUCTION AREAS	57
3.1.1. EAST BLOCK COAL SEAMS AND PRODUCTION PLANNING	57
3.1.1.1. MINING METHOD TO BE APPLIED IN EAST PRODUCTION BLOCK	62
3.1.1.2. ROCK MECHANICS AND CUTTABILITY STUDIES FOR EQUIPMENT SELECTION.....	65
3.1.1.3. FACE EQUIPMENT TO BE USED IN EAST PRODUCTION BLOCK	67
3.1.1.4. PACK WALL SYSTEM TO BE APPLIED IN MAINGATES OF EAST PRODUCTION BLOCK .	70
3.1.2. WEST BLOCK COAL SEAMS AND PRODUCTION PLANNING.....	70
3.1.2.1. SHALLOW COALS (WEST BLOCK)	73
3.1.2.1.1. Proposed Production Method for Shallow Coals	73
3.1.2.1.2. Shallow Block Coal Seams And Production Panels.....	75
3.1.2.1.3. Face Equipment.....	79
3.1.2.2. WEST BLOCK COALS.....	81
3.1.2.2.1. MINING METHOD TO BE APPLIED IN WEST PRODUCTION BLOCK.....	84
3.1.2.2.2. FACE EQUIPMENT TO BE USED IN WEST PRODUCTION BLOCK	85
3.1.2.2.3. PACK WALL SYSTEM TO BE APPLIED IN MAINGATES OF WEST PRODUCTION BLOCK	87
3.1.3. SOUTHEAST BLOCK COAL SEAMS AND PRODUCTION PLANNING	87
3.1.3.1. MINING METHOD TO BE APPLIED IN SOUTHEAST PRODUCTION BLOCK.....	90
3.1.3.2. FACE EQUIPMENT OF SOUTHEAST PRODUCTION BLOCK	90
3.1.3.3. PACKWALL SYSTEM TO BE APPLIED IN MAINGATES OF SOUTHEAST PRODUCTION	
BLOCK	90
3.2. RESERVE AND TIMELINES OF PRODUCTION AREAS	91
3.3. PRECAUTIONS TO REDUCE RISKS IN PRODUCTION	91
3.3.1. RISK OF COAL SEAMS.....	91
3.3.2. RISK OF GAS AND DUST OUTBURST	92
3.3.3. RISK OF SPONTANEOUS COMBUSTION	92
3.3.4. WORKER’S TRAINING RELATED TO WORK ACCIDENTS	92
3.3.5. SUBSIDENCE EFFECT TO DUE PRODUCTION.....	92
3.4. PRODUCTION BY YEARS.....	93
3.4.1. OVERALL PRODUCTION	93
3.4.2. EAST BLOCK PRODUCTION	93
3.4.3. WEST BLOCK PRODUCTION	94
3.4.4. SOUTHEAST BLOCK PRODUCTION.....	94
3.4.5. SHALLOW COAL PRODUCTION	95
3.4.6. GATEWAYS PRODUCTION	95
3.5. GATEWAY EQUIPMENT LIFE	96
3.6. FACE EQUIPMENT LIFE	96
4. MINE VENTILATION	96

4.1. MAIN PRINCIPLES OF VENTILATION	96
4.2. EXHAUST FANS THAT WILL BE USED IN MAIN VENTILATION.....	97
4.3. VENTILATION PLAN	98
4.4. METHANE DRAINAGE METHODS TO BE APPLIED.....	100
5. MAIN HAULAGE SYSTEMS	102
5.1. COAL AND WASTE ROCK HAULAGE.....	102
5.1.1. EAST PRODUCTION BLOCK COAL HAULAGE ROADS AND EQUIPMENT	102
5.1.2. WEST PRODUCTION BLOCK COAL HAULAGE ROADS AND EQUIPMENT	103
5.1.3. SOUTHEAST PRODUCTION BLOCK COAL HAULAGE ROADS AND EQUIPMENT	103
5.2. MATERIAL AND MEN TRANSPORTATION	103
5.2.1. MEN AND MATERIAL TRANSPORTATION OF EAST PRODUCTION BLOCK	103
5.2.2. MEN AND MATERIAL TRANSPORTATION OF WEST PRODUCTION BLOCK.....	103
5.2.3. MEN AND MATERIAL TRANSPORTATION OF SOUTHEAST PRODUCTION BLOCK.....	104
5.3. TRANSPORTATION PLAN	105
6. OTHER FACILITIES IN UNDERGROUND	106
6.1. COMPRESSED AIR, HYDRAULIC AND WATER LINES.....	106
6.1.1. COMPRESSED AIR FACILITIES.....	106
6.1.2. HYDRAULIC PUMP STATIONS	106
6.1.2.1. EAST PRODUCTION BLOCK HYDRAULIC PUMP STATION	106
6.1.2.2. WEST PRODUCTION BLOCK HYDRAULIC PUMP STATION	106
6.1.2.3. SOUTHEAST PRODUCTION BLOCK HYDRAULIC PUMP STATION	106
6.2. WATER DRAINAGE.....	107
6.2.1. EFFECT OF GROUND WATER TO THE PRODUCTION IN THE FIELD.....	107
6.3. CONTROL-COMMAND CENTER	108
7. COAL WASHING PLANT, COAL PREPERATION AND MARKETING	110
7.1. COAL WASHING PLANT.....	110
7.2. POTENTIAL MARKET IN TURKEY	111
7.3. STOCK YARD, SILOS AND TRANSPORTATION UNITS.....	115
7.3.1. TRANSPORTATION VIA HIGHWAY	115
8. AUXILIARY SURFACE FACILITIES PROJECT AND PLANNING	116
8.1. ELECTRIC ENERGY SUPPLY AND TOTAL POWER.....	116
8.1.1. TRANSMISSION LINE.....	116
8.1.2. MAIN SUBSTATIONS	118
8.1.3. SINGLE LINE POWER FLOW CHART	118
8.2. SURFACE FACILITIES.....	121

9.	ENVIRONMENTAL ASSESSMENT.....	122
9.1.	LANDSCAPING	122
9.2.	INDUSTRIAL WASTE WATER TREATMENT PLANT.....	122
9.3.	DOMESTIC WASTE WATER TREATMENT PLANT.....	123
9.4.	OTHER WASTES	123
9.5.	DUMPING AREA PLANNING.....	123
10.	EMPLOYMENT, LABOR PLANNING AND ORGANOGRAM	124
10.1.	LABOR REQUIRMENT BY YEARS	124
10.2.	ORGANOGRAM.....	129
11.	INVESTMENTS, OPERATIONAL COSTS AND UNIT COSTS.....	130
11.1.	INVESTMENTS.....	130
11.1.1.	AMOUNT OF INVESTMENTS.....	130
11.1.2.	INVESTMENT ITEMS	130
11.2.	OPERATIONAL COSTS	131
11.2.1.	LABOR.....	132
11.2.2.	ENERGY AND WATER.....	132
11.2.3.	HEADING WORKS IN THE SEAM	132
11.2.4.	CONSUMABLES.....	133
11.2.5.	MAINTANANCE SERVICES.....	133
11.2.6.	OPERATIONAL COSTS OF WASHING PLANT	133
11.2.7.	DISPOSAL AREA AND LANDSCAPING	133
11.2.8.	GENERAL AND ADMINISTRATIVE COSTS	133
11.2.9.	ROYALTY	133
11.2.10.	AMORTIZATION	133
11.2.11.	DYNAMITE & DETONATORS	134
11.2.12.	SOCIAL SECURITY PAYMENTS AND COMPENSATIONS.....	134
11.3.	ASSUMPTIONS OF COST CALCULATION	135
11.4.	COST ESTIMATIONS.....	136

TABLE LIST

Table 1. Resource Estimation Study Results	23
Table 2. Average Analysis of East Block Coals	24
Table 3. Average Analysis of Southeast Block Coals.....	24
Table 4. Average Analysis of West Block Coals	25
Table 5. Average Analysis of West Shallow Seams	25
Table 6. Excavation-Concrete Comparison at Shafts.....	28
Table 7. Galleries of East Production Block	39
Table 8. Galleries of West Production Block.....	40
Table 9. Galleries of Southeast Production Block	40
Table 10. The earthquakes that have occurred in provincial border of Bartın and $M \geq 2$ between 1990 and 2008.....	44
Table 11. Secure shotcrete thickness calculation	48
Table 12. Panels of East EC100	59
Table 13. Panels of East EC-200.....	59
Table 14. Panels of East EC300	60
Table 15. Panels of East EC400	60
Table 16. Panels of East EC500	61
Table 17. Panels of East EC600	61
Table 18. Small Scale Cutting Test Results	65
Table 19. Block Sample UCS Test Results.....	66
Table 20. Core Sample UCS Test Results (by Sandvik).....	66
Table 21. Point Load Test Results	66
Table 22. Production Panels of WSC300.....	76
Table 23. Production Panels of WSC400.....	77
Table 24. Production Panels of WSC500.....	77
Table 25. Production Panels of WSC600.....	78
Table 26. Production Panels of WSA100.....	78
Table 27. Production Panels of WSA200.....	79
Table 28. Panels of West WA100	81
Table 29. Panels of West WA200	82
Table 30. Panels of West WA300	82
Table 31. Panels of West WA400	83
Table 32. Panels of West WA500	83
Table 33. Panels of West WA600	83
Table 34. Panels of WA700	84
Table 35. Production Panels of Southeast SEC400.....	89
Table 36. Production Panels of Southeast SEC500.....	89
Table 37. Liberated Methane Measurement at TTK Colliery Drifts in 1997	96
Table 38. RoM and Washed Coal Production Distribution	113
Table 39. Screen Analysis of Westphalian-C Coal	114
Table 40. Screen Analysis of Westphalian-A Coal.....	114
Table 41. Clean Coal Screen Analysis of Westphalian-C Coal	114
Table 42. Clean Coal Screen Analysis of Westphalian-A Coal	115
Table 43. Energy Demand by Years	116
Table 44. Water Consumption At U/G Activities	122
Table 45. Labor Plan of Full Mechanized Panel	124
Table 46. Labor Plan of Developments.....	124

Table 47. Labor Plan of Yearly 1,5 Million Ton Production Out of 1 Full-Mechanized Panels (2014-2016).....	124
Table 48. Labor Plan of Yearly 2,5/3,0 Million Ton Production Out of 2 Full-Mechanized Panels (2017-2018)	125
Table 49. Labor Plan of Yearly 4,5 Million Ton Production Out of 3 Full-Mechanized Panels (2019-2025 & 2031-2037)	127
Table 50. Labor Plan of Yearly 5 Million Ton Production Out of 4 Full-Mechanized Panels (2026-2032).....	128
Table 51. Annual Investments of HEMA Amasra Hardcoal Project	130
Table 52. Personnel Number Distribution of Amasra-B and Shallow Coals.....	132
Table 53. Investment and Operational Costs per Year (Amasra-B & Shallow Coals)	134
Table 54. Annual Production Tonnages of Amasra-B and Shallow Coals	135

FIGURES LIST

Figure 1. Sectional Drawing of Shaft No.1	29
Figure 2. Sectional Drawing of Shaft No.2	30
Figure 3. Sectional Drawing of Shaft No.3	31
Figure 4. Shaft No.1 Skip-Skip Hoisting Parameters.....	33
Figure 5. Shaft No.1 Cage-Counterweight Hoisting Parameters	34
Figure 6. Shaft No.2 Skip-Counterweight Hoisting Parameters	35
Figure 7. Shaft No.2 Cage-Counterweight Hoisting Parameters	36
Figure 8. Shaft No.2 Cage-Counterweight at Heavy Load	37
Figure 9. Shaft No.3 Cage-Counterweight Hoisting Parameters	38
Figure 10. Earthquake Zoning Map of Turkey	43
Figure 11. Earthquake Zoning Map of Bartın	44
Figure 12. The earthquakes that have occurred in survey area and $M \geq 2$	46
Figure 13. B24 Gallery (Net Section 24 m ²)	50
Figure 14. B18 Gallery (Net Section 18 m ²)	51
Figure 15. Support Type-1	52
Figure 16. Support Type-2	52
Figure 17. Support Type-3	53
Figure 18. East Production Block	58
Figure 19. Generalized Sequence of Longwall Mining Method	63
Figure 20. Coal Production in Full-Mechanized Longwall Method	63
Figure 21. Coal Production Sequence In Full-Mechanized Longwall Method.....	64
Figure 22. Shearer-Loader and Powered Roof Supports.....	64
Figure 23. Model view of powered roof support	67
Figure 24. Cross section of powered roof support	67
Figure 25. Plan view of powered roof support	68
Figure 26. Shearer Loader	68
Figure 27. AFC and Stage Loader.....	69
Figure 28. Crusher.....	69
Figure 29. Pack Wall System	70
Figure 30. West Production Block	72
Figure 31. Drilling of blast holes into cutting face	73
Figure 32. Opening of the front-shield to secure roof after blasting.....	74
Figure 33. Taking the coal from gobsite	74
Figure 34. Offsetting the support after closing hinged shield	74
Figure 35. Taking cutting-face coal and dinting of the floor	75
Figure 36. Offsetting of the conveyor	75
Figure 37. Coal Driller	80
Figure 38. Hydraulic support for low seams (Type-I)	80
Figure 39. Hydraulic support for high seams (Type-II)	80
Figure 40. Cross section of powered roof support with plow-1	85
Figure 41. Cross section of powered roof support with plow-2.....	85
Figure 42. Cross section of powered roof support	85
Figure 43. Plan view of powered roof support.....	86
Figure 44. Southeast Production Block.....	88
Figure 45. Curve of Distance Effect of Surrounding Seam Methane Concentration to the Production Face.....	97
Figure 46. Ventilation Plan	99
Figure 47. Methane Drainage Methods To Be Applied	100
Figure 48. Plan View of Drainage Method:4	101

Figure 49. Cross Section of Method:4 Parallel to Face Direction	101
Figure 50. Cross Section of Method:4 Vertical to Face Direction.....	101
Figure 51. Production, Personnel and Material Transportation Plan	105
Figure 52. Control, Communication and Monitoring System.....	109
Figure 53. 2x1272MCM Transmission Line from 154 kV of TEİAŞ to Kazpınar DC	117
Figure 54. Connection of 31,5 kV Shaft Switchgears to 31,5 kV Transmission Line.....	117
Figure 55. Shaft No.1 Power Diagram	118
Figure 56. Shaft No.1 Underground Power Diagram.....	119
Figure 57. Shaft No.2 Power Diagram	119
Figure 58. Shaft No.2 Underground Power Diagram.....	120
Figure 59. Shaft No.3 Power Diagram	120
Figure 60. Shaft No.3 Underground Power Diagram.....	121

GRAPH LIST

Graph 1. Overall Production Graph	93
Graph 2. East Block Annual Production Graph	93
Graph 3. West Block Annual Production Graph.....	94
Graph 4. Southeast Annual Production Graph	94
Graph 5. Shallow Coals Annual Production Graph	95
Graph 6. Gateways Annual Production Graph.....	95

APPENDIX LIST

- Appendix-1 Panel layout_ WA300 & EC300
- Appendix-2 Panel layout_ WA400 & EC400 & SEC400
- Appendix-3 Panel layout_ WA500 & EC500 & SEC500
- Appendix-4 Panel layout_ WA600 & EC600
- Appendix-5 Panel layout_ WA700
- Appendix-6 Panel layout_ WA100 & EC100
- Appendix-7 Panel layout_ WA200 & EC200
- Appendix-8 Major Developments (Shafts and Galleries) Timeline
- Appendix-9 East Field Full Mechanized Panels Production Timeline
- Appendix-10.A. Highway Transportation Routes
- Appendix-10.B. New Road Tunnel Cross Section
- Appendix-10.C. Correspondences of Road Transportation
- Appendix-10.D. Correspondences of Road Transportation
- Appendix-10.E. Transportation Capacity Report (in Turkish)
- Appendix-11 West Field Full Mechanized Panels Production Timeline
- Appendix-12 Southeast Field Full Mechanized Panels Production Timeline
- Appendix-13 Overall Production Timeline
- Appendix-14.A. Recoverable Reserve Calculation
- Appendix-14.B. Recoverable Reserve Calculation of Shallow Coals
- Appendix-15.A. Mechanization Selection and Production Timeline
- Appendix-15.B. Mechanization Selection and Production Timeline Shallow Coal
- Appendix-16 Shaft No.3 Ventilation Building Plan View
- Appendix-17 Ventilation Building Cross Sectional Drawing
- Appendix-18 Annual Production Rates by Block Basis
- Appendix-19 Pack Wall Info-1-2-3
- Appendix-20 -510 Inset of Shaft No.1
- Appendix-21 -510 Shaft Bottom Layout Gallery of Shaft No.1
- Appendix-22 -510 Inset of Shaft No.2
- Appendix-23 -510 Shaft Bottom Layout Gallery of Shaft No.2
- Appendix-24 -410 Inset of Shaft No.2
- Appendix-25 -410 Shaft Bottom Layout Gallery of Shaft No.2
- Appendix-26 -410 Inset of Shaft No.3
- Appendix-27 -410 Shaft Bottom Layout Gallery of Shaft No.3
- Appendix-28 -510 Pump Room of Shaft No.1
- Appendix-29 -410 Pump Room of Shaft No.2
- Appendix-30 -510 Pump Room of Shaft No.2
- Appendix-31 -410 Pump Room of Shaft No.3
- Appendix-32 Longitudinal Section of Shafts
- Appendix-33 Production, Men and Material Transportation Plan
- Appendix-34 Overall Ventilation Layout
- Appendix-35 Settlements Above Production Fields
- Appendix-36.A. Schedule of Investments
- Appendix-36.B. Opex & Costs
- Appendix-37 Methane Concentrations
- Appendix-38 Characteristic Curve of Exhaust FansGVhv30-1300-2W

- Appendix-38 Characteristic Curve of Exhaust FansGVhv32-2000-2W
- Appendix-39.A Washability Studies of Amasra Coals
- Appendix-39.B. Equipment List of Amasra-B Washing Plant
- Appendix-39.C. Equipment List of Shallow Coals Washing Plant
- Appendix-40.A. Washing Plant Flow Sheet
- Appendix-40.B. Washing Plant Flow Sheet Shallow Coals
- Appendix-41.A. Energy Requirement of Underground Facilities
- Appendix-41.B. Low Seam Longwall Panels Power Requirement
- Appendix-41.C. High Seam Longwall Panels Power Requirement
- Appendix-41.D. Gateway Development Power Requirement
- Appendix-41.E. General Line Schemes
- Appendix-41.F. Overall Power Requirement Details-1
- Appendix-41.G. Overall Power Requirement Details-2
- Appendix-41.H. Longwall Energy Train
- Appendix-41.I. Gateway Development System Layout
- Appendix-42 Surface Layout of Shaft No.1
- Appendix-43 Surface Layout of Shaft No.2
- Appendix-44 Surface Layout of Shaft No.3
- Appendix-45.A. Resource Estimation Study (Revised Oct'13)
- Appendix-45.B. Detailed Chemical Analysis Results
- Appendix-46 ITU Cutting Test Results
- Appendix-47 ZKU Geotechnical Report
- Appendix-48 Sandvik Report
- Appendix-49 Geotechnical Report of Pilot-1 Borehole
- Appendix-50.A The Hydrogeological Report of Amasra Hardcoal Basin-1
- Appendix-50.B The Hydrogeological Report of Amasra Hardcoal Basin-2
- Appendix-51.A Overall Timeline
- Appendix-51.B Overall Timeline Summary
- Appendix-52 Panel layout_WSA100 & WSC300
- Appendix-53 Panel layout_WSA200 & WSC400
- Appendix-54 Panel layout_WSC500
- Appendix-55 Panel layout_WSC600
- Appendix-56 West Shallow Coals Development & Production Schedule
- Appendix-57 East Field Ventilation Plan
- Appendix-58 West Field Ventilation Plan
- Appendix-59 Southeast Field Ventilation Plan
- Appendix-60 Organogram of Amasra Project
- Appendix-61 Geology Files
- Electronic Copies of Surface Facilities Static, Electrical Drawings

1. GEOLOGY

1.1. GENERAL GEOLOGY OF THE FIELD

1.1.1. Palaeozoic

In the working site, Paleozoic aged units are consisted of Carboniferous and Permian aged formations.

1.1.1.1. Carboniferous

The basin consists of Carboniferous aged Yılanlı formation consisting of dolomite, limestone and dolomitic limestone, Namurian aged Alacağzı formation consisting of clay stone, siltstone, sandstone and thin coal seams with plant that has Culm facies characteristic, Westphalia A aged Kozlu formation consisting of conglomerate, sandstone, siltstone, claystone and coal that has river facies characteristics, Westphalia BCD aged Karadon formation consisting of conglomerate, sandstone, generally siltstone, clay stone and coal that has river facies characteristics.

1.1.1.1.1. Yılanlı Formation (Devonian - Visean)

It is a deposit that is formed by interbedded with limestone, dolomitic limestone and dolomite. Although limestone and dolomite are generally observed in Devonian aged, limestone with chert gravel and chert banded are observed in Visean (Carboniferous) rocks. The colour varies as like as grey, black, dark brown and light brown. Asphaltite and gas output was observed in the quarry where located 1 km away from the north of Gürgenpınar, between Bartın and Inkum.

This shows that the formation is formed in the resifal ambience, the sedimentation area is quite shallow (not more than 50-60 m) in this time interval and the temprature is more than 20°.

1.1.1.1.2. Alacağzı Formation (Namurian)

Alacağzı formation which is the initial of getting shallow and terrestrial periods, is formed by interbedded with sandstone, siltstone. There is almost 5 m transgression in the Tarlağzı region. Sandstone, siltstone and claystone are usually composed by clayed and carbonated cement also can decompose easily when it contact with air.

The most important characteristic of Alacağzı formation is the congression. The congression types are steroidal or disposidal. The congressions are formed by increasing carbonated liquid concentration and it is conculuded that is completed during diagenetic period. There are small scaled cross bedding, flaser bedding and congressions as layer structure.

Alacağzı formation indicates getting shallow. If there is abundant haulm, trace of fossil plant in this formation, it shows the transition of the getting shallow from sea conditions to deltaic sediments. Delta front sediments are a portion of partly above sea and partly under sea of the upper part of the delta. Some formations with lenticular shaped carbonates in Tarlağzı indicate the part which is under sea of delta. Zonguldak basin is getting shallow with Yılanlı formation, and passes to the delta ambience with Alacağzı formation. After passing the well-

drained boggy ambiance, it has been worsened by decreasing drainage and then a wide hard coal basin is formed by the domination of the bad-drained boggy ambiance with Westphalian.

1.1.1.1.3. Kozlu - Karadon Formations (Westphalian)

The units which coal production is performed are formed of two formations from bottom to top. These are Kozlu Formation (Westphalia A) and Karadon Formation (Westphalia BCD).

II. Kozlu Formation (Westphalian A)

Kozlu formation is determined by distinct sedimentary structures, concave cross bedding, parallel lamination and stratification, eroded (washout) floor, grading, clay and coal lag sediment, plant-root trace etc. Facies properties. It is seen that braided and meander stream systems dominate in Kozlu formation. In large scale cross stratifications and according to the measurements that are done in respect of the long axis of the pebbles, it is determined that the paleo-stream of the unit is generally in north and northwest direction. The formation has been formed from sequent subsidence of channel and flood plain sediments. Channel sediments have eroded the flood plain sediments in patches. The erosion has affected coal seams; some of the coal seams have totally been eroded and some of them have become thinner by the erosion. In the first 300m of Kozlu formation, the flood plain sediments are dominant. Channel sediments increase through bottom. In East Area, there is 5 m high red-coloured sandstone which can be guide level is determined by 4 drillings at 200m under the schieferton which form the bottom of Westphalia-C in Westphalia-A.

III. Karadon Formation (Westphalian Bcd)

It outcrops around Tarlaağzı and Gömü Villages. This formation has been analyzed in three units. These units are Westphalia B, Westphalia C and Westphalia D.

Westphalian B (WB)

The lower boundary of this unit does not separate from Kozlu formation. It can be ascertained with palynological data. Lithologically, it consists of gray, dark gray-coloured sandstones, siltstone, claystone and coal seams. Flood plain sediments are generally dominant. It reminds upper levels of Kozlu formation.

The coal seams with 0.05-0.90m thicknesses are common in this unit. The thicknesses of Westphalia B unit are approximately 200m.

Westphalian C (WC)

It takes place between the units of Westphalia B and Westphalia D. Its lower boundary is refractory clay which is accepted as guide level. In geophysics drilling logs, it is seen that the radioactivity of refractory clay is high. The refractory clay has been determined as argillaceous slate (Schieferon) in coreholes.

Lithologically, it consists of gray, white coloured conglomerate and sandstones, and black, dark gray coloured claystone, siltstones and coal. It has been observed that there are black, brown, caramel brown coloured schieferton levels and caramel brown coloured siderite levels at drilling.

The quality of the schieferton that is taken for guide changes from bottom to top. The black, dark black, brown coloured schieferton at the upper part has a very good quality; brown, dark

brown coloured schieferton in the middle part has a good quality; the caramel brown coloured schieferton at the bottom part has a bad quality. If the colour becomes darker, the quality becomes better.

6 economical coal seams are exploited by Amasra Hard Coal Enterprise.

The refractory clay level in Tavan seam (EC300) has been determined as a second guide level in Westphalia C. Illit, kaolinite, quartz minerals have been determined in the X-ray analysis done in this clay. The thickness of this level ranges between 0.05-0.35m. Its colour is white, gray white. Tavan seam is recognized as macro owing to this second guide level.

Westphalian D (WD)

Lithologically, it has been formed from red green (mostly), gray, dark gray, green, green-blue coloured claystone, siltstone, white-gray coloured conglomerate and sandstone, black, caramel brown coloured schiefertons. This unit settles on Westphalia C and its thickness is approximately 200-250m. It increases towards East and South. The determined seams are thin and have generally not exploitable features.

1.1.1.2. Arıtdere Formation

Its lithology has intervals with sandstone, rare claystone, and rare conglomerate. Grains have been occurred by combining quartz pieces and red coloured cement with clay. Although the claystone levels of the formation indicate thin-middle bedding, conglomerate and sandstone levels indicate middle and massive bedding. The bedding is common most of parts. There is widely tectonical activity in Çakraz formation. Generally, its connection with the other deposits is tectonic. Also, there are Carboniferous aged coal seam slices throughout thrust zones. This colour of the formation has occurred under terrestrial conditions, due to some traces of sedimentary structure. Existing some rare gypsum in the formation brings with drying sea residue, lacustrine ambient conditions. Also, traces for showing the effect of terrestrial and desert climates can be seen.

1.1.2. Mesozoic

It is seen in the areas except Paleozoic aged formations have outcropped. It is represented with Cretaceous aged formations. The Cretaceous aged units will be analyzed as Lower Cretaceous and Upper Cretaceous aged formations.

1.4.2.1. Lower Cretaceous

It is represented with Gömü and Amasra formations in Bartın-Amasra basin.

1.1.2.1.1. Gömü Formation

It outcrops around Tarlaağzı Village, Gömü Village, Amasra, İnpiri and Abbas Villages. It is concordant with Amasra formation at the top. It settles as discordant on Paleozoic aged formations at the bottom.

Lithologically, sometimes there are conglomerating levels at the bottom. The gravels of these conglomerating levels belong to Yılanlı, Alacağzı, Kozlu-Karadon formations (Çapakdere).

After these conglomerating levels continuing a few times, red colored sandstone levels with carbonate cement exists. Then the sea gets deeper and limestone subsidence exists. Sandstone is completely represented by limestone after limestone sequence. Limestone is gray, white, gray-beige and caramel brown colored. It has been formed of limestone and dolomite which is parallel to bedding, has vertical irregular fractures with calcite and pyrite fillings, has intermediate-thick bed and has massif appearance in patches. It is determined in paleontological evaluations that it is upper Jura- Barremien aged.

The variation of thickness has indicated that the depositional environmental of Gömü Formation had been so undulating. The thickness has get thicker from south to southeast and southwest.

1.1.2.1.2. Amasra Formation

It outcrops around Amasra Şah District, İnpiri, Gömü, Ahatlar. Amasra formation is concordant with Gömü formation at the bottom, discordant with Ahatlar formation at the top. On Amasra Gömü Village İnağzı hill, its ammonite having sections is seen.

Lithologically, it exists as sandstone with carbonate, claystone, siltstone levels which consists ammonite fossils around Gömü Village. It has too much concretion around Amasra Şah District. It has gray leaden ashen color. It has been formed by sequence of gray, gray blue marl and sandstone with carbonate cement and also clay and siltstone. Stratification is not so clear. It represents flysch facies characteristics. It is determined in age analyses done with ammonites that its age is Apsian-Albian.

1.4.2.2. Upper Cretaceous

Upper Cretaceous aged formations in Bartın-Amasra Hard Coal basin, from bottom to top, are as follows;

- 1- Ahatlar Formation
- 2- Askersuyu Formation
- 3- Dinlence Formation
- 4- Uğurlar Formation
- 5- Kazpınar Formation
- 6- Alaplı Formation

1.1.2.2.1. Ahatlar Formation

It outcrops around Amasra Bakacak location, Ahatlar Village, Meşeliktepe and Karainler Village. It is discordant with Gömü and Amasra formation at the bottom, it settles as discordant on Paleozoic aged formations where Lower Cretaceous units erode. The top is concordant with Askersuyu formation. It has shallow sea property.

Lithologically it has formed from gray, grayish white colored, sandy, intermediate thick bedded, sandy limestone with vugs. It has been cut by all the drillings that has started in upper cretaceous. It covers top of Askersuyu Formation and the units are Lower Cretaceous and Paleozoic aged. Its thickness ranges between 15-35 m. It is Senomanian aged.

1.1.2.2.2. Askersuyu Formation

It is exposed around Çömlekkıran Hill, Amasra Bakacak location, Ahatlar and Karainler Village. It is concordant with Ahatlar Formation at the bottom; the top is graceful passing Dinlence Formation.

Lithologically it has formed from pink, mealy gray, white colored marly limestone. It is in the form of plaque with thin intermediate bed.

It is bottom of Upper Cretaceous. It is continuous with Ahatlar Formation as a band at the contacts of formations. Therefore it is considered as a guide formation of Upper Cretaceous. The thickness variation is between 5 and 25m.

1.1.2.2.3. Igneous Rocks

Rocks as tuff, agglomerate etc. has formed after an action that sometimes stabilizes beginning from Turonian, sometimes increases its activity and continue until the end of Campanian. Pillow lava, instantaneous cooling trace, pyroclastics, sequence of deep sea sediments indicates that this volcanism is an undersea volcanism.

I. Dinlence Formation

It outcrops around Dinlence, Meşelik, Çömlekkıran hills. It has been formed by sequence of agglomerate, tuff, marly limestone and Andesitic tuff. But agglomerate and tuff sequence, marly limestone is a formation that varies with Andesitic lava and undersea landslide. Tuff intercalations rather frequently exist in Dinlence formation. Marl, claystone and sandstone are seen in this imbricate.

There is stratification between Bartın-Amasra. Stratification becomes clear where sandstone, claystone, marl, tuffite intercalations exist by the grains become finer.

Askersuyu formation exists at the bottom. It is passed to Dinlence formation from this unit by stages according to decreasing carbonate amount, increasing detrital levels.

Dinlence formation is the result of a fast volcanic activity and a quick sedimentation due to north way of Neotetis subduct Pontite like type of Chile. It represents a part of volcanic sedimentary sequencing as a result arc volcanism. The materials, coming in the result of island arc volcanism, have filled the trench area of the basin and then Dinlence formation has formed. It has been cut in 30-350 m of thickness in the drillings done in the basin. Its age has been determined as Santonian-Koniasian in the paleontologic analyses

II. Uğurlar Formation

It outcrops around Bostanlar Village, Uğurlar Village, and Kazpınar Village. Lithologically it has been formed by marl, clayey limestone and tuff sequence. It is in the form of thin intermediate stratification. It contains rarely agglomerate levels. Usually the well-cementation is in marly levels and clayey limestones. Uğurlar formation can be

recognized easily because of its color and due to its place which is between two volcanic formations having different properties. Dinlence formation exists under Uğurlar formation. The passing occurs in patches by tuff levels, claystone and marl. It is concordant with Kazpınar formation at the bottom. It has been reached a conclusion that this unit has subsided at sea where there is a contact with volcanic active zone by the reason that it consists some inputs as tuffite and consisting of planktonic foraminifera very much. The age of this formation has been determined as Kampanian in the result of paleontologic data.

III. Kazpınar Formation

It outcrops around Taşköprü location, Harman hill, Kazpınar Village, Namazlar hill, Bostanlar Village.

Lithologically it has been formed of andesite, latite andezit, pyroxene andesite due to evaluations of macro and petrographical analyses. It generally has rocks which consist of white colored plagioclase, few hornblendes and biotite crystals in pink, green, gray colored cement in macro prospects.

It is concordant with Uğurlar formation at the bottom. At the top, Alaplı formation settles with angular discordance. The island arc volcanism occurs due to the oceanic plate subducts beneath continental plate. In this field, island arc volcanism occurs due to oceanic plate subducts continental plate like type of Chile. This volcanism occurs as a result of Tethys sea subducts Pontits. This volcanism had continued between Turonian and last of medial Eosen. Kazpınar Formation occurred at the period of max lava flow. It is Kampanian aged.

1.1.2.2.4. Alaplı Formation

Alaplı Formation is usually seen as marl in many places. But, there are argillic limestone, claystone, tuff, rare siltstone and sandstone as sub-levels. The colour of formation is generally white, light yellow, rarely pink red and green. Green is rather dominant where clay rate is higher. Stratification is thin at marl levels and thick at mid-argillic levels. Stratification can be seen clearly. Yellow-white colored, fine-mid layered, mid-frequency sandstone is identified in Alaplı Formation which situated with angular conformity above andesit in Bartın Hatipler Village. Plants and scape remains are seen in sandstone. Nearby Bartın Kalafatoğlu Village, Alaplı Formation also situated with angular conformity above andesit. Whilst Alaplı Formation sedimentation volcanism that's been ongoing since the beginning of the Late Cretaceous was paused. At this point a shallow conditioned sedimentation, deepening in stabil sea, but allows lamellae and ekinit life is formed. Alaplı Formation characterizes low energetic, shallow but sometimes deeper environment.

The age of this formation has been determined as Meastrichtian in the result of paleontologic data.

1.1.3. Senozoic

2.1. Quaternary

It is characterized by quaternary alluvion and slope debris in Bartın-Amasra hard coal basin. Slope debris has been composed of bonded angled grains of limestone and volcanic sourced rocks.

2.2. REGIONAL GEOLOGY OF THE FIELD

In the working site, the most ancient Paleozoic aged rocks are the Yılanlı formation which is formed between the range of Devonian-Vizeen. The formations contained hard coal, being the most important ore in the basin, are settled on the Yılanlı formation. Alacağzı formation, is Namurian aged and has thin coal seams, is settled on the Yılanlı formation. 2 formations with abundantly coal are lay on Alacağzı formation. First one is Westfaliyen A aged Kozlu formation. Westfaliyen BCD aged Karadon formation lay on Kozlu formation. Permian aged Artidere formation which is the last of the Paleozoic aged formations, is settled on the Karadon formation in the site.

Mesozoic aged formations lay on Paleozoic aged formations by transgression.

Gömü formation consisting of Barramian-Jura aged limestone, lay on Paleozoic aged formations as discordance, in the region. Apsien-Albian aged Amasra formation, which is formed by flish type rocks, lay on Gömü formation compatibly.

The region has been raised and eroded with the effect of Austric phase after Lower Cretaceous.

Upper Cretaceous aged formations lay on Lower Cretaceous formations as discordant and it lays on Paleozoic aged formations where Lower Cretaceous formations have been eroded. Senomanian aged Ahatlar formation, which is formed by sandy limestone, lay on Amasra formation from Lower Cretaceous units as discordant. Turonian aged Askersuyu formation that is formed by plated marly limestone lay conveniently on this formation. Santonian – Coniacian aged Dinlence formation which is formed from interbedded with andesite as an undersea volcanism product, tuff, marl and agglomerate lay on Askersuyu formation. Campanian aged Uğurlar formation which is formed by interbedded with marl-clayish limestone, tuff, are settled on this formation. Uğurlar formation is covered by Campanian aged Kazpınar formation consisting of andesite, tuff and marn dominantly. Meastrichtiyen aged Alaplı formation consisting of marly limestone which is the last of Cretaceous, lay on Kazpınar formation Senozoic is represented by Quaternary aged talus and alluvion in the basin.

The basin is generally affected by Hercynian and Alp orogenesis. After it has been folded and faulted, it took the existing structure.

2.3. OCCURRING OF THE REGIONAL GEOLOGY OF THE FIELD

A very big part of the work area was situated under a shallow sea ambient during subsiding of Upper Devonian-Visean aged units that are accepted as base. We can say that this ambient has formed after Devonian sea become shallow. At the end of Visean, sea become getting shallower, the ambient become an available place to live. At this time, work area has been face to a delta ambient that is passing to a marshy area having too much fresh water inlet.

Namurian aged Alacağzı formation having sandstone, siltstone, claystone sequence, and limestone levels in patches, plant, and leaf, lot of fragment and traces, thin coal seams in upper levels.

In Namurian, fresh water comings decreases, the ambient changes to a march. Meanwhile, an ambient, which was available for forests with large log and leaves to be formed, was coming into being. Therefore, Westphalia aged Kozlu-Karadon formations, which are composed of conglomerate, sandstone, claystone, siltstone and exploitable coal seam sequence and are the hard coal potential of the country, have subsided.

This ambient is fairly available for the living beings to live in Westphalia. Arıtdere formation, which has a large area beginning from the east of the basin, is impossible for the living beings to live, is a dead formation, is Permian aged and consists of red colored sandstone, conglomerate, siltstone and claystone, has subsided.

The region has remained as rock for a long time beginning from Permian to Upper Jura-Lower Cretaceous. The region has been subject to effective erosion. Upper Jura- Lower Cretaceous transgression starts with bottom conglomerate. The limestones, which are subsiding after the ambient gets deeper, are in Urgonian facies. The sea ambient gets shallower after Barremian. Absian-Albian aged Amasra formation consisting of sandstone, clay and siltstone in Flysch facies has subsided.

Senomanian aged detrital limestone characterized Gömü formation settles on Amasra formation. The sea gets deeper after Senomanian and Turonian aged Askersuyu formation, consisting of limestone with plaque and marl, has subsided.

The undersea volcanic actions have been started in Upper Senomanian-Turonian. Volcanism product units have subsided as sequence with marly limestones. Campanian aged volcanic actions have stopped with andesite lava outlet.

These formations have subsided during volcanic actions. Santonian-Coniasian aged Andesitic tuff, Dinlence formation forming from marly claystone and agglomerate, Campanian aged Uğurlar formation forming from the sequence of tuff tuffite and marly claystone, Kazpınar formation forming from andesites (the last product of volcanism). The subsiding have continued by the volcanism has concluded and Alaplı formation has subsided. Meastrichtian aged Alaplı formation consisting of marly limestone is the youngest lithological unit of the work area.

The Upper Cretaceous sediments have settled on Lower Cretaceous sediments discordantly by the effect of Austric Phase after the interruption.

2.4. STRUCTURAL GEOLOGY

The Paleozoic formations, which have folded, faulted and been subject to various dislocations by Hercynian affect in Bartın-Amasra hard coal basin, have been subject to structural changes after shear zones, overturned fold and repetitions at the result of secondary deformation by the affect of Alpine orogeny with Mesozoic formations that come with transgression. This situation has become the main reason of the problems in correlation studies in productive carboniferous which is the abstract of the studies.

The direction of the folds that occur with Hercynian orogeny is Northwest-Southeast. The direction of the folds that occur with Alpine orogeny is Northeast-Southwest. Alacaağzı and Kozlu-Karadon formations are under Cretaceous aged formations in the west of Amasra road. The near surface sections of these formations have been subject to tectonic activities, have been faulted and folded. The lower levels of these formations have been subject to less dislocation than upper levels. It is determined in SJ-10, SJ-32, SJ-51, SJ-58, SJ-61, SJ-75 SJ-78, K-1, K-4, K-5, K-7, K-25, K-31, K-33, AK-4, Hema-2 and Hema-38 drillings that Kozlu formation has overlapped on Karadon formation in the result of reverse fault. The slope of Paleozoic formations is less and they become stabilized while the hole gets deeper in the drillings that are on the west side of Bartın-Amasra road and nearby this road. This has been determined in cores. K-1, K-4, K-5, K-7, K-23, K-31, K-33, K-34 drillings are examples of this. In these drillings, Kozlu formation has settled on Karadon formation, has dragged a part of Karadon formation and has caused the raise of the thickness of Karadon formation.

1.4.1. Folds

The folds in working area have been formed by the effect of Hercynian and Alpine orogeneses.

1.4.1.1. Folds That Have Been Fold By Hercynian Orogeny

1.4.1.1.1. Gavurpınar Syncline

Its axis is in the direction of Southeast-Northwest, Alacaağzı formation exists on its core. Yılanlı formation settles on its both sides.

There is İnkum anticline on its Northwest and Dıştaşlık anticline on its Northeast. It has deformed the units on the core of the synclinal by being subject to the effects of the forces with Northeast-Southwest direction.

1.4.1.1.2. Dıştaşlık Anticlinal

Its axis is in the direction of Northwest-Southwest, Yılanlı formation exists on its core. Alacaağzı formation settles on its both sides.

Gavurpınar synclinal exists between Amasra and Tarlaağzı basin. Its northeast side is a natural fold that is fractured by fault.

1.4.1.1.3. Amasra - Tarlaağzı Basin

This basin, accepted as synclinal, has a very fractured and folded structure.

Beginning from Yılanlı Formation till the Karadon Formation, all of the Carboniferous aged units are located in this basin. Bottom of this basin rises around Amasra. In drill-holes SJ-23, SJ-43, SJ-45, below Alacağzı Formation, Yılanlı Formation is cut. This basin's base gets deeper towards South – Southeast and East.

1.4.1.2. Folds That Have Been Formed By Alpine Orogeny

1.4.1.2.1. Uğurlar Anticlinal

Its axis is in the direction of Northeast-Southwest. Dinlence formation exists on its core. Uğurlar and Kazpınar formations settle on its both sides. It is a symmetric fold and it has been faulted in fold axis.

1.4.1.2.2. Kazpınar Syncline

It is at the Northwest side of Uğurlar anticline. Its axis is in the direction of Northeast-Southwest. Its axis is parallel to the axis of Uğurlar anticline. Alaplı formation exists on its synclinal core. It is in the form of a symmetric fold.

1.4.2. Faults

The faults, which are seen in Amasra-Tarlağzı at the north of the basin, are normal and reverse faults. Extensions are in directions North – Northwest, South – Southwest, East – West, North – Northeast and North to South.

The faults are analyzed in two parts; faults that can be seen on the surface and mantled faults.

1.4.2.1. Surface Faults

- 1- Two reverse faults cutting each other, which are seen in Süzekdere and lay through Domuzburnu, Taşboğaz, T., have affected Alacağzı and Yılanlı formations.
- 2- The reverse faults that effect Lower Cretaceous and Paleozoic formations with actions (Alpine Orogeny) after Lower Cretaceous in Northeast. These faults have caused repetitions in Paleozoic aged formations at the bottom.
- 3- In Gömü Formation north of Tarlağzı and Ahatlar, many listric faults are observed.

1.4.2.2. Mantled Faults

- 1- The central reverse fault that effect Westphalia aged formations in SJ-10, SJ-51, SJ-58, SJ-61, SJ-75, K-1, K-4, K-5, K-7, K-21, K-25, AK-4, Hema-2 and Hema-38. By the effect of this fault, Kozlu series settled on Karadon formation. Towards to east thickness of Kozlu Formation reduces. In these drillings, formations are pinched; the inclinations are high by the effect of reverse fault. The inclinations decrease and stability increase beginning from the bottom of thrust plane. This two reverse faults negatively affected Productive Carboniferous at the west of Bartın – Amasra road. Kozlu Formation is overlapped over itself by the effect of those two reverse faults, e.g. SJ-61 and K-8, and in some places overlapped over Karadon Formation.
- 2- Despite the inclination of guide horizons in K-11 and K-12 are low, the guide horizon in K-12 has been cut in 120 m higher than K-11. It is supposed to be a fault with vertical slip in the light of this data.
- 3- Reverse fault that caused Namurian, that is identified with drill holes SJ-65, SJ-66, Hema-13, Hema-20 and Hema-43 overlaps Westphalia A sequences.

- 4- Tuna fault, close to SJ-32 and AK-12 drill holes, where south block rises and primarily in direction of east – west and then north east direction.
- 5- Normal fault that is close to North of SJ-7 and is seen in drill holes Hema-32 and K-19. According to borehole data, ave. 110m slip has been identified for this fault.
- 6- Normal fault that occurs between drill holes SJ-15 and K-36.
- 7- Normal fault, that is parallel to the central fault, along the drill holes AK-8, K-6, K-2, K-8.

1.4.2.3. Orogeny And Phases

Bartın-Amasra basin has been subject to the effects of Hercynian and Alpine Orogeny. It has become an ascending rock by the effect of Sudet phase after Upper Devonian-Lower Carboniferous. Upper Carboniferous units have subsided on this altitude. After Upper Carboniferous, the west of the region has ascended (Austrian), the subsiding of the Permian aged units has continued and settled on Westphalia units.

The region has stayed as a rock after Permian for a long time (Paletic phase) and has been subject to sea invasion in Upper Jura- Lower Cretaceous. The Upper Jura- Lower Cretaceous units have settled on Paleozoic units transgressively.

At the end of Lower Cretaceous, the region has ascended again, become a rock and Lower Cretaceous units has been eroded in somewhere. (Subhercynic-Austrian phase)

In upper Cretaceous, the region has been subject to sea invasion again. The Upper Cretaceous units have settled on Lower Cretaceous units. The upper Cretaceous units have subsided on Paleozoic aged units transgressively with angled discordance where Lower Cretaceous units have been eroded.

The undersea volcanism actions have started in the region in Upper Cretaceous, it has continued up to Meastrichtian. At the end of Campanian, the volcanic actions have stopped after the andesites, which are the last products of volcanic actions, have settled in. The sea has started to get deeper and Alaplı formation has subsided on andesites.

Bartın Amasra basin is the core of anticline and synclinal that formed after Alpine Orogeny. Most of the Paleozoic aged units have occurred with tearing of these anticline axes and being subject to eroding.

The region has taken its structure in consequence of folds, faults and erosions after Cretaceous.

1.5. RESOURCE AND RESERVE STUDIES

Resource and reserve estimations, that have been completed by several companies and organizations, was revised by SLR Company and formed as stated below.

Measured Resource: 413 Mt.

Indicated+Inferred Resource: 160 Mt.

Total Resource: 573 Mt.

An up-to-date resource estimation study has also been prepared and given as Appendix-45. This resource estimation study for 17,67 km² was completed based on drilling results. A geological loss factor is identified between 10-20% in this study considering borehole intervals, discontinuities, seam thickness variance etc. This resource estimation study, which is according to JORC, was held by HEMA geologists who have been carrying out the determination studies and following drilling works from the very beginning of project. Assistance was taken from MTA when required. Results of resource estimation study is given in Table 1.

Table 1. Resource Estimation Study Results

	East Block (Total)		West Block (Total)		Southeast Block (Total)		West Shallow Project (Total)		TOTAL	
	GTIS (Mt)	TTIS (Mt)	GTIS (Mt)	TTIS (Mt)	GTIS (Mt)	TTIS (Mt)	GTIS (Mt)	TTIS (Mt)	GTIS (Mt)	TTIS (Mt)
Measured	62,11	55,38	31,41	27,18	15,58	14,02	6,89	5,51	115,99	102,09
Indicated	19,83	17,70	17,38	15,03	18,00	16,20	1,58	1,27	56,79	50,20
Inferred	5,36	4,78	3,96	3,43	6,29	5,66	0,17	0,13	15,78	14,00
TOTAL RESOURCE	87,30	77,86	52,75	45,64	39,87	35,88	8,64	6,91	188,56	166,29

1.6. CHEMICAL ANALYSIS OF COALS IN LICENSE FIELD

Coal samples were taken during gallery developments and from boreholes. All samples were collected by HEMA geologists on site and sent to accredited laboratories such as Istanbul Technical University, Bulent Ecevit University, NormLab, AGLab, MTA Lab. according to purpose of test. Details regarding coal sampling is given in Appendix-45A. Resource Estimation Study. HEMA have collected 525 samples during the geological investigation program. Details of these samples, the labs where they are tested and the analysis results, can be viewed in Appendix-45.B.

This table provides the details of where the samples were collected (borehole, channel etc.), the size and the numbers of samples, the specific laboratory where the tests were undertaken and who undertook the test.

Analysis results given in below tables (Table 2, Table 3, Table 4, Table 5) are representing the all license field coal seams based on all drill boreholes in entire field. Thus, arithmetical average results in original basis and dry basis are given based on collected data from boreholes. Moisture, ash, volatile matter, fixed carbon, total sulphur content as well as FSI and calorific value results are listed in below tables.

However, given coal quality information for each panel in mine plans (Appendix-1-2-3-4-5-6-7) are consisting of effective area of borehole data, which are located on each panel, in order to represent coal to be produced.

Table 2. Average Analysis of East Block Coals

	Test Type	Moisture (%)	Ash (%)	Volatile Matter (%)	Fixed Carbon (%)	Total Sulphur (%)	FSI	Upper CV (kcal/kg)	Lower CV (kcal/kg)
EC100	Original Basis	2,58	30,40	27,74	39,29	0,68	1	5102	4906
	Dry Basis	-	31,25	28,47	40,28	0,70		5236	5050
EC200	Original Basis	2,39	31,81	27,19	38,61	0,98	1	4970	4778
	Dry Basis	-	32,64	27,84	39,52	1,00		5087	4905
EC300	Original Basis	2,73	26,88	28,68	41,21	0,60	1	5433	5219
	Dry Basis	-	27,76	29,44	42,27	0,61		5574	5372
EC400	Original Basis	2,22	25,47	29,80	42,51	0,86	1	5569	5343
	Dry Basis	-	26,09	30,46	43,45	0,88		5684	5476
EC500	Original Basis	2,15	22,41	31,50	43,94	0,78	1	5857	5317
	Dry Basis	-	22,96	32,17	44,87	0,80		5979	5762
EC600	Original Basis	1,98	30,99	29,18	37,55	0,52	1	5152	4957
	Dry Basis	-	31,67	29,78	38,23	0,53		5252	5064
Ave.	Original Basis	2,27	26,44	29,79	41,25	0,69	1	5503	5209
	Dry Basis	-	27,12	30,46	42,21	0,71		5622	5418

Table 3. Average Analysis of Southeast Block Coals

	Test Type	Moisture (%)	Ash (%)	Volatile Matter (%)	Fixed Carbon (%)	Total Sulphur (%)	FSI	Upper CV (kcal/kg)	Lower CV (kcal/kg)
SEC400	Original Basis	2,06	22,21	32,11	43,63	0,83	2	5932	5714
	Dry Basis	-	22,71	32,77	44,52	0,85		6053	5845
SEC500	Original Basis	2,21	25,93	29,75	42,11	0,93	2	5555	5344
	Dry Basis	-	26,47	30,44	43,08	0,95		5685	5482
Ave.	Original Basis	2,13	24,07	30,93	42,87	0,88	2	5743	5529
	Dry Basis	-	24,59	31,61	43,80	0,90		5869	5664

Table 4. Average Analysis of West Block Coals

	Test Type	Moisture (%)	Ash (%)	Volatile Matter (%)	Fixed Carbon (%)	Total Sulphur (%)	FSI	Upper CV (kcal/kg)	Lower CV (kcal/kg)
WA100	Original Basis	1,50	15,89	33,50	49,10	1,09	3	6809	6568
	Dry Basis	-	16,13	34,01	49,85	1,11		6912	6677
WA200	Original Basis	1,25	14,86	33,07	49,84	0,63	3	6850	6604
	Dry Basis	-	15,14	33,71	50,82	0,64		6983	6744
WA300	Original Basis	2,20	16,00	30,28	51,52	0,55	4	6714	6471
	Dry Basis	-	16,43	30,94	52,62	0,57		6859	6593
WA400	Original Basis	2,43	8,20	32,21	57,16	0,46	4	7502	7242
	Dry Basis	-	8,13	33,03	58,58	0,47		7690	7438
WA500	Original Basis	1,84	9,68	32,55	55,93	0,49	5	7492	7161
	Dry Basis	-	9,85	33,17	56,98	0,50		7556	7307
WA600	Original Basis	1,53	20,79	29,78	47,90	0,74	5	6498	6271
	Dry Basis	-	21,07	30,26	48,68	0,75		6553	6381
WA700	Original Basis	1,42	38,34	23,51	36,73	0,55	4	4731	4562
	Dry Basis	-	38,88	23,85	37,26	0,56		4800	4637
Ave.	Original Basis	1,74	17,68	30,70	49,74	0,64	4	6657	6411
	Dry Basis	-	17,95	31,28	50,68	0,66		6765	6540

Table 5. Average Analysis of West Shallow Seams

	Test Type	Moisture (%)	Ash (%)	Volatile Matter (%)	Fixed Carbon (%)	Total Sulphur (%)	Upper CV (kcal/kg)	Lower CV (kcal/kg)
WSC300	Original Basis	7,65	23,39	29,63	39,32	1,39	5163	4938
	Dry Basis	-	25,27	32,11	41,62	1,39	5596	5399
WSC400	Original Basis	5,89	38,05	26,31	29,74	1,10	3869	3691
	Dry Basis	-	40,27	28,02	31,71	1,17	4126	3972
WSC500	Original Basis	6,36	25,72	31,10	36,81	1,21	5112	4889
	Dry Basis	-	27,46	33,21	39,58	1,29	5460	5260
WSC600	Original Basis	8,10	26,14	29,41	36,35	0,63	4934	4705

	Dry Basis	-	28,44	32,00	39,56	0,69	5369	5171
WSA100	Original Basis	4,51	21,26	27,97	46,40	0,44	5726	5511
	Dry Basis	-	22,21	29,25	48,53	0,46	5989	5789
WSA200	Original Basis	3,94	18,51	29,35	48,19	0,41	6070	5843
	Dry Basis	-	19,28	30,54	50,16	0,43	6318	6105
Ave.	Original Basis	6,08	25,51	28,96	39,47	0,86	5146	4929
	Dry Basis	-	27,16	30,86	41,86	0,91	5476	5283

1.7. DRILLING WORKS

Totally 88 boreholes have been completed in 84663m with 2 core drilling rigs that are capacited 1100m and 3 core drilling rigs that is capacited 1500m and 1 core drilling rig that is capacited 2000m in order to clarify the continuity of coal seams and tectonism, to be able to correlate between boreholes by Hema up to today. After core logging, lithological logs have been prepared. Meanwhile information of the boreholes is confirmed by geophysical logs such as Gamma-Ray, Neutron, Dipmeter, and Density. Geophysical studies were held by accredited companies. Information of boreholes with geophysical logs are given in tables of Chapter 4 Appendix-45 Resource Estimation Study. Of the 222 boreholes drilled 99 have been geophysically logged. This logging has been undertaken by MTA and Bayer company. Also chemical analysesses of the coal seams have been done by private companies; meanwhile the dating has been done in our palinology labrotary. The cores have been kept in our storage that is located to Shaft 3 side closely.

81 rotary boreholes and 53 core boreholes have been completed by M.T.A previously. Totaly there have been 222 boreholes in our licenced field with 88 core boreholes that have been done by Hema. Our drilling program is still in progress. HEMA have 6 drilling rigs working on Amasra Projects. These machines are being used on boreholes for the exploration of the southern part of the license area, to improve information of the immediate production area and to supplement information where previous boreholes of insufficient depth.

Since HEMA have been responsible for their own exploration drilling program, HEMA have experienced core recoveries in the coal bearing strata averaging 99,55%. Details can be found in Appendix-45.A. Appendix-45.A provides the specification of the boreholes (core size, core barrels etc.).

Tectonic map of the field has been prepared as a result of core logging and cross-section works with corrent informations taking from boreholes.

Cross-sections works, facies and coal seam correlations have been done with evaluating all informations. In our eastern Block, total 6 coal seams, which are WC aged and occuring in Karadon formation, numbered EC-100, 200, 300, 400, 500 and 600 have been correlated as a reserve calculating app. 45,0 million tonnes in 4,2 km². In our southern-east Block, total 2 coal seams, which are WC aged and occuring in Karadon formation, numbered SEC-400,

SEC-500 have been correlated as a reserve calculating app. 21,0 million tonnes in 3,7 km². In western Block, total 7 coal seams, which are WA aged and occurring Kozlu formation, numbered WA-100, 200, 300, 400, 500, 600, 700 have been correlated as reserve calculating app. 37,0 million tonnes in 4,1 km². In West Shallow Block, 6 seams which are WC aged WSC300,400,500,600 and WA aged WSA100, 200 have been correlated as reserve calculating app. 3,5 million tones in 1,2km².

2. UNDERGROUND MAJOR DEVELOPMENTS AND PLANNING

2.1. HOIST SHAFTS

Shaft No.1 has 700 m, Shaft No.2 has 730 m and Shaft No.3 has 579 m depth. Longitudinal section of shafts is attached as Appendix-32.

Hoisting of coal is planned from Shaft No. 1 with skip system. Hoisting of waste material is planned from Shaft No.1, No.2 and No. 3 with cage systems. Surface layout is planned according to these systems. Shaft No. 1 will have both skip and cage system, thus it will be used for both personnel and material transport.

2.1.1. EXCAVATION-CONCRETE COMPARISON AT SHAFTS

Minimum concrete thickness in shafts are 50 cm. Concrete thicknesses related parameters are listed in Table 6.

Table 6. Excavation-Concrete Comparison at Shafts

Parameter	SHAFTS		
	Shaft No.1	Shaft No.2	Shaft No.3
Total Excavation Volume (m ³)	39718	46526	32852
Total Concrete Volume (m ³)	8795	10303	7275
Hole (per m ²)	0,75	0,75	0,75

2.1.2. SHAFT SECTIONS

NO. 1 SKIP AND HOISTING SHAFT

Shaft No. 1 is planned with an 8 meter diameter as cage-counterweight system in order to serve for personnel and material transportation and skip-skip system for coal extraction. It's planned with a single cage with two deck each deck can carry 5 m³ mine car. There will be double skip (Figure 1). Shaft rope system is planned with guide and koepe. Fresh air will be sent via this shaft.

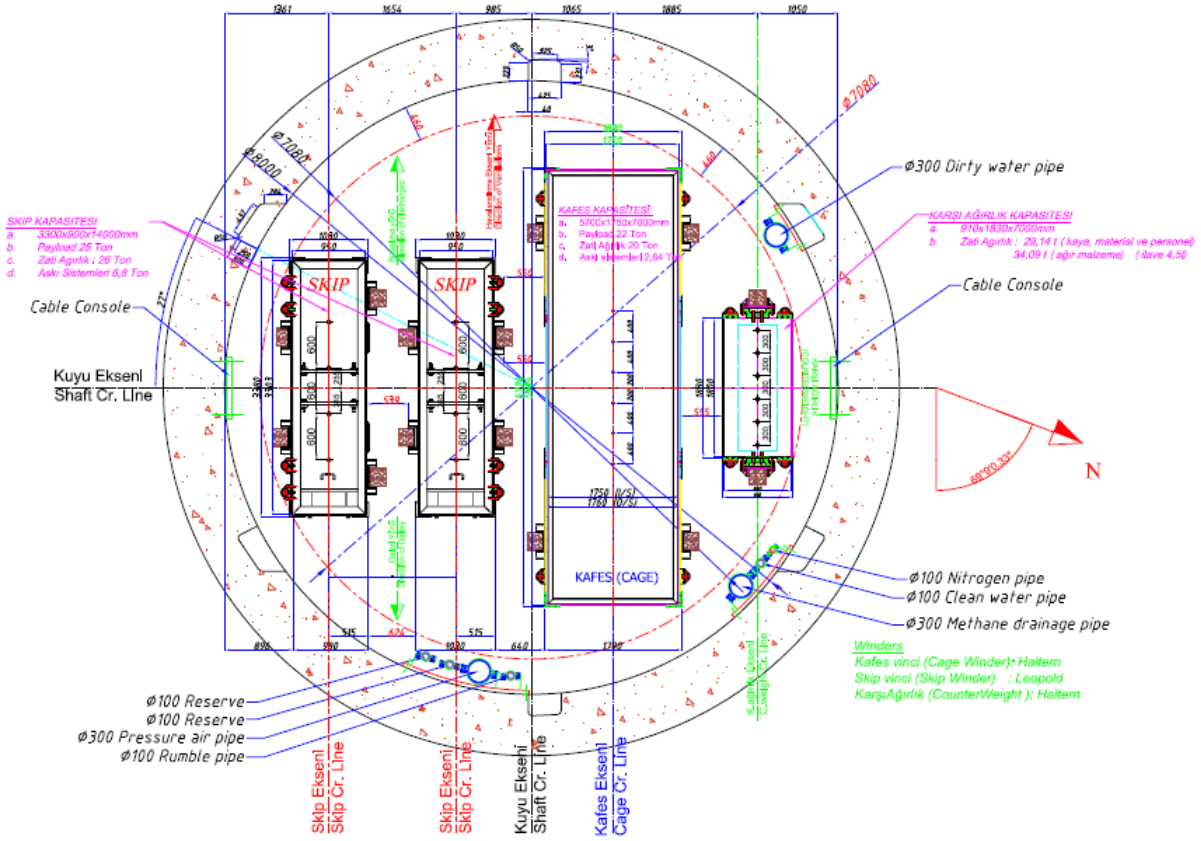

Figure 1. Sectional Drawing of Shaft No.1

NO. 2 SKIP AND HOISTING SHAFT

Shaft No. 2 is planned with an 8 meter diameter as cage-counterweight system and skip-counterweight system in order to serve for personnel-material transportation and for production by skip. It's planned with a single cage with two deck each can carry 5 m³ mine car and 15 ton capacity skip compartment. Shaft rope system is planned with guide and koepe (Figure 2). This shaft will serve as downcast shaft for West Block.

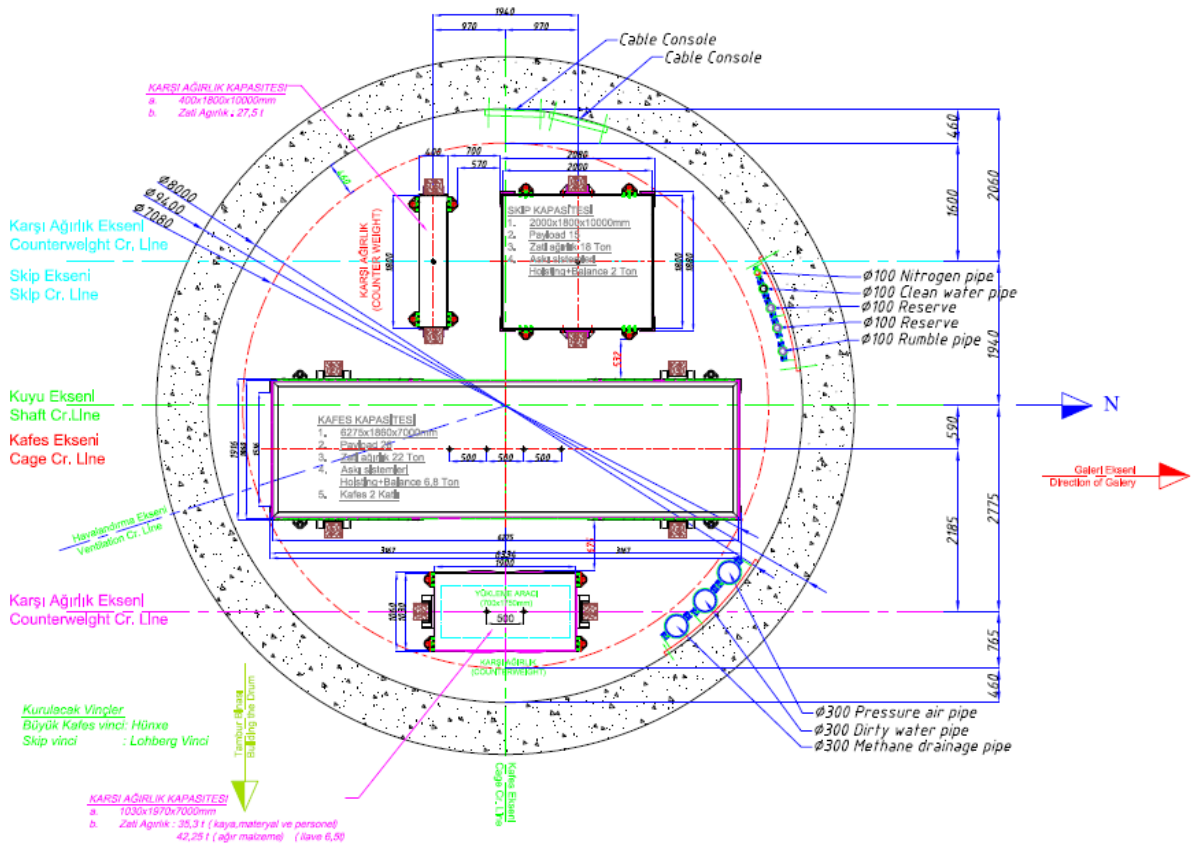

Figure 2. Sectional Drawing of Shaft No.2

NO. 3 VENTILATION AND HOISTING SHAFT

Shaft No. 3 is planned with an 8 meter diameter as cage-counterweight system in order to serve for personnel-material transportation. It's planned with a single cage with three deck each can carry 5 m³ mine car. Shaft rope system is planned with guide and koepe. This shaft will serve as ventilation shaft (upcast) (Figure 3).

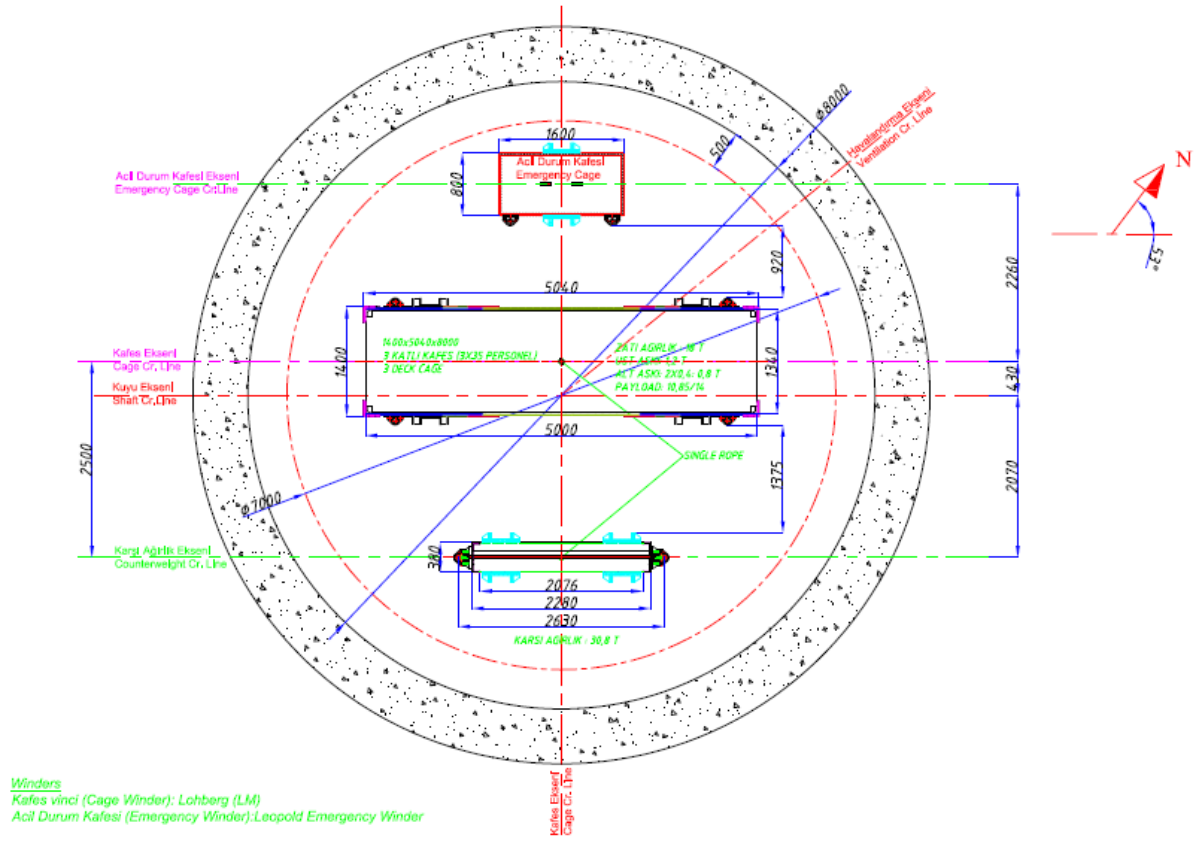

Figure 3. Sectional Drawing of Shaft No.3

2.1.3. INSETS

-410 and -510 are chosen as main levels since Shaft No.1 will serve as production, material hoisting, men transportation and also intake air shaft. Accordingly, double-sided -410 and -510 insets have been constructed. (Appendix-20)

Shaft No.2 has, double-sided -410 and -510 inset. (Appendices-22, 24). This shaft will be used for material hoisting and men transportation.

Shaft No.3 is upcast shaft. In case of need, this shaft could be used for material transportation as well. Accordingly, -410, -510 double-sided insets have been constructed (Appendix-21).

2.1.4. SHAFT STATIONS

2.1.4.1. SHAFT STATION OF SHAFT NO.1

Hoisting is planned to be done with shaft stations, 5 m³ volume mine car circulation on 150 meter length part, integrated with main belt conveyor system. In Shaft No.1 coal hoisting will be done with skip and material/men transport will be done with cage. Technical drawings of shaft stations of each shaft are attached as Appendix-21, Appendix-23, Appendix-25 and Appendix-27.

Inset construction and support works of Shaft No.1 -510 level, Shaft No.2 -410 and -510 level, Shaft No.3 -410 level are completed. Technical drawings of insets of each shaft are attached as Appendix-20, Appendix-22, Appendix-24 and Appendix-26.

SHAFT NO.1 STATION – COAL HAULAGE (BELT CONVEYOR ROUTE)

Coal produced will be transported to three silos, each has 500 ton capacity, by a 24 m² section and concrete supported gallery at Shaft No.1. Coal will be transported to the skip loading station by belt conveyor in the gallery under silos. Here, coal will be automatically loaded to skip hoisting system and will be sent to surface.

Production belt will be installed at main roadway No.3705.

Production of East Block will be transported with belt conveyors to the bottom of Shaft No.1 via horizontal 3703, 3705, galleries and 3602, 1612 inclined galleries (Appendix-21).

Production of West Block and Southeast Block will be transported to the Surface +90 Mine Entrance via 2412 incline, 2703, 2502, 2202, 3052 and 3053 horizontal galleries (Appendix-21).

SHAFT NO.1 STATION – MATERIAL AND MEN TRANSPORT (LOCOMOTIVE ROUTE)

Empty cars, which will be sent down to -510 level by cage, will be pushed across to the “empty car part” of shaft station. Loaded cars will be sent to loaded-empty cross-point of shaft station. From this point cars will be sent to shaft bottom by crane maneuver or chains and will be loaded to cage by a push rod.

Material transportation will be done starting at main roadway No.3704. This roadway will be connected to connection galleries and then to the panels. Monorail system will be used for material transportation.

Material and men transport of East Block will be done via horizontal 3704, 1703 galleries by loco, and via inclined 1612 gallery by monorail (Appendix-21).

2.1.4.2. SHAFT STATION OF SHAFT NO.2

Technical drawing of -510 shaft station of Shaft No.2, that will be the men and material entrance shaft, is attached as Appendix-23. Technical drawing of -410 shaft station is attached as Appendix-25.

2.1.4.3. SHAFT STATION OF SHAFT NO.3

Technical drawing of -410 shaft station of Shaft No.3, that will be the ventilation shaft, is attached as Appendix-27. Ventilation building plan view and cross sectional drawings are also given as Appendix-16 and Appendix-17, respectively.

2.1.5. HOISTING CAPACITIES OF SHAFTS

Hoisting calculations of Shaft No.1 is given in below Figure 4 and Figure 5.

Shaft No.1 Skip-Skip:

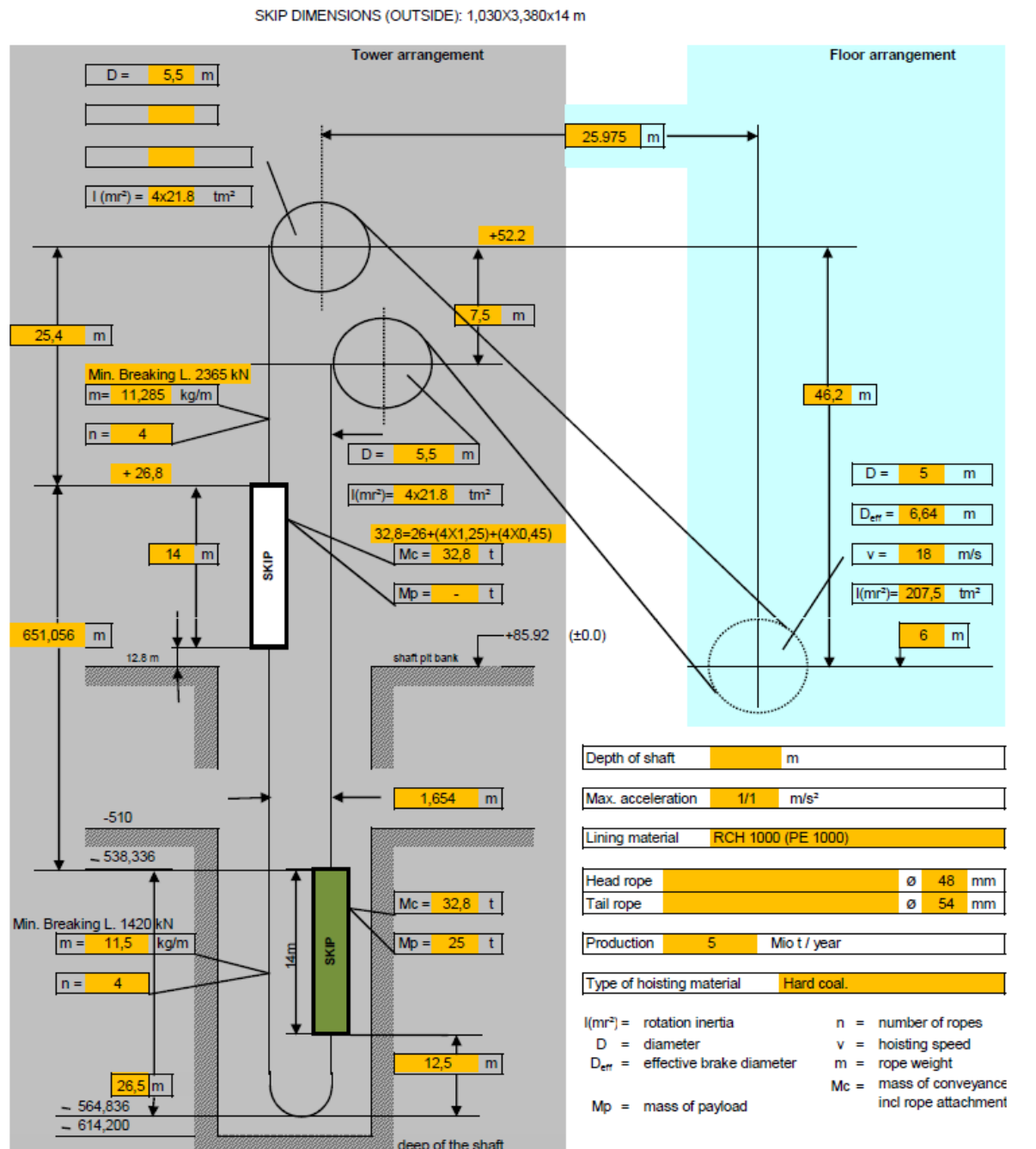

Figure 4. Shaft No.1 Skip-Skip Hoisting Parameters

Shaft No.1 Cage-Counterweight:

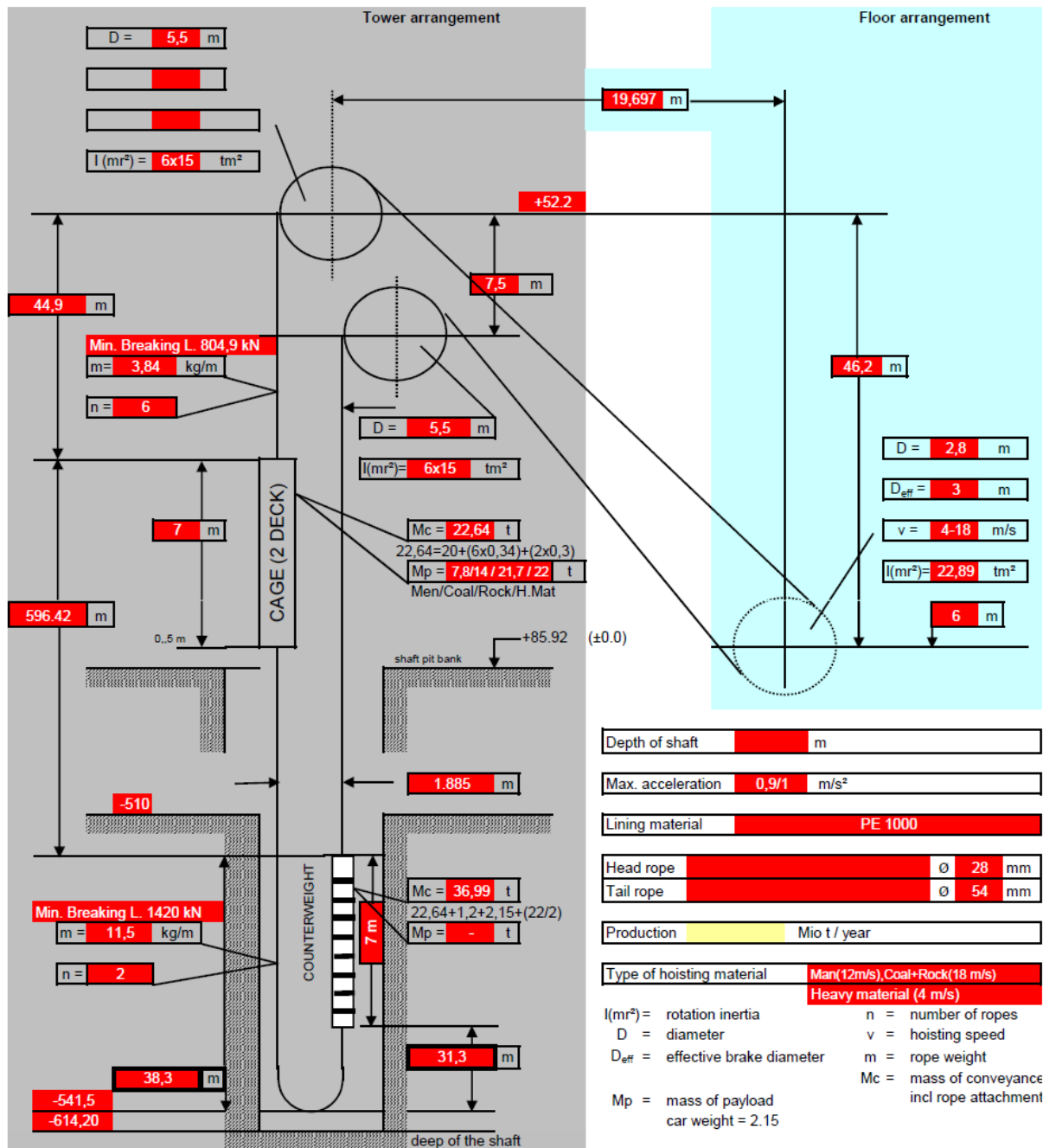

Figure 5. Shaft No.1 Cage-Counterweight Hoisting Parameters

Hoisting calculations of Shaft No.2 is given in below Figure 6, Figure 7 and Figure 8.

Shaft No.2 Skip-Counterweight:

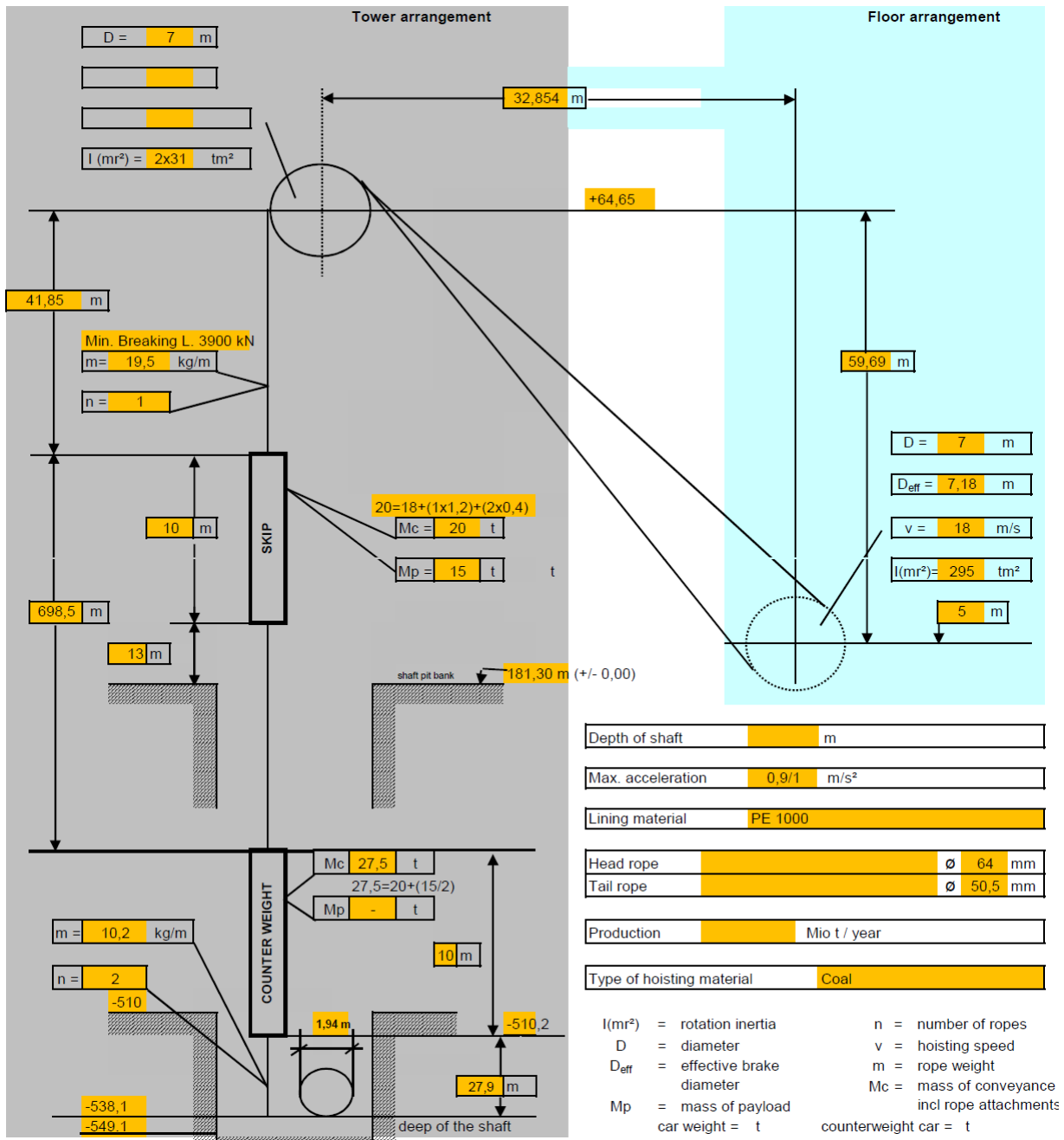

Figure 6. Shaft No.2 Skip-Counterweight Hoisting Parameters

Shaft No.2 Cage-Counterweight:

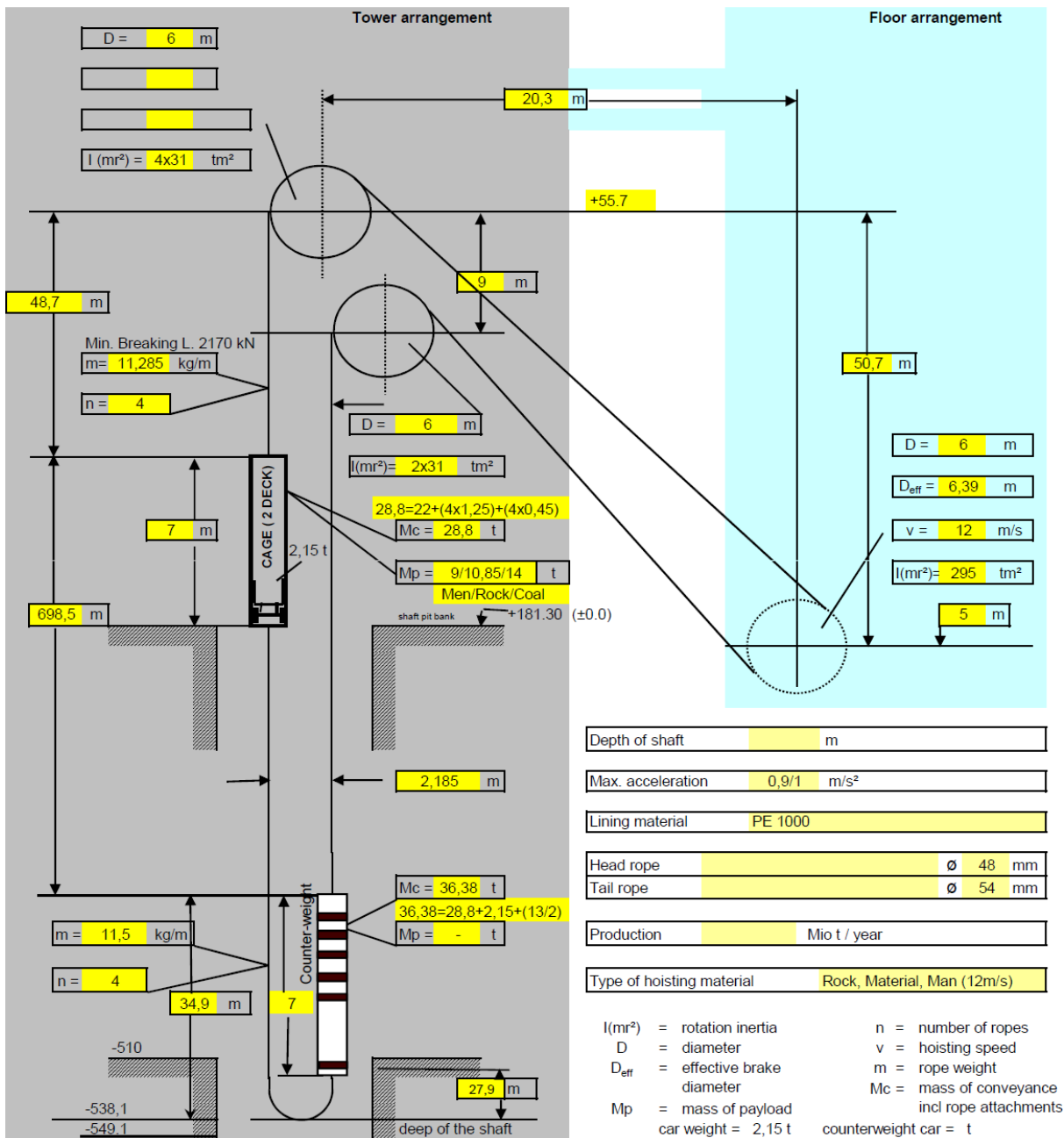

Figure 7. Shaft No.2 Cage-Counterweight Hoisting Parameters

Shaft No.2 Cage-Counterweight at heavy load:

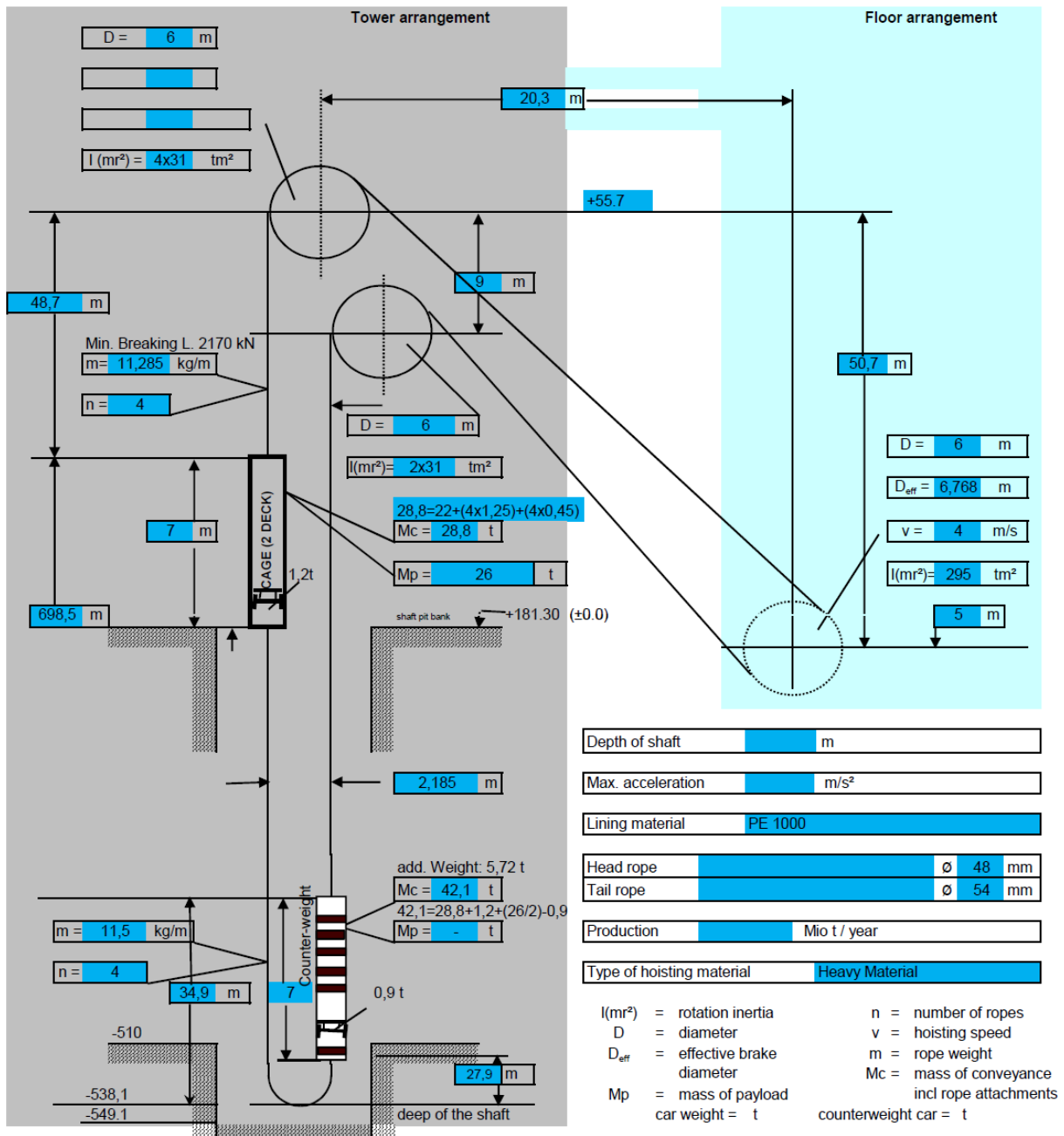

Figure 8. Shaft No.2 Cage-Counterweight at Heavy Load

Hoisting calculations of Shaft No.3 is given in below Figure 9.

Shaft No.3 Cage-Counterweight:

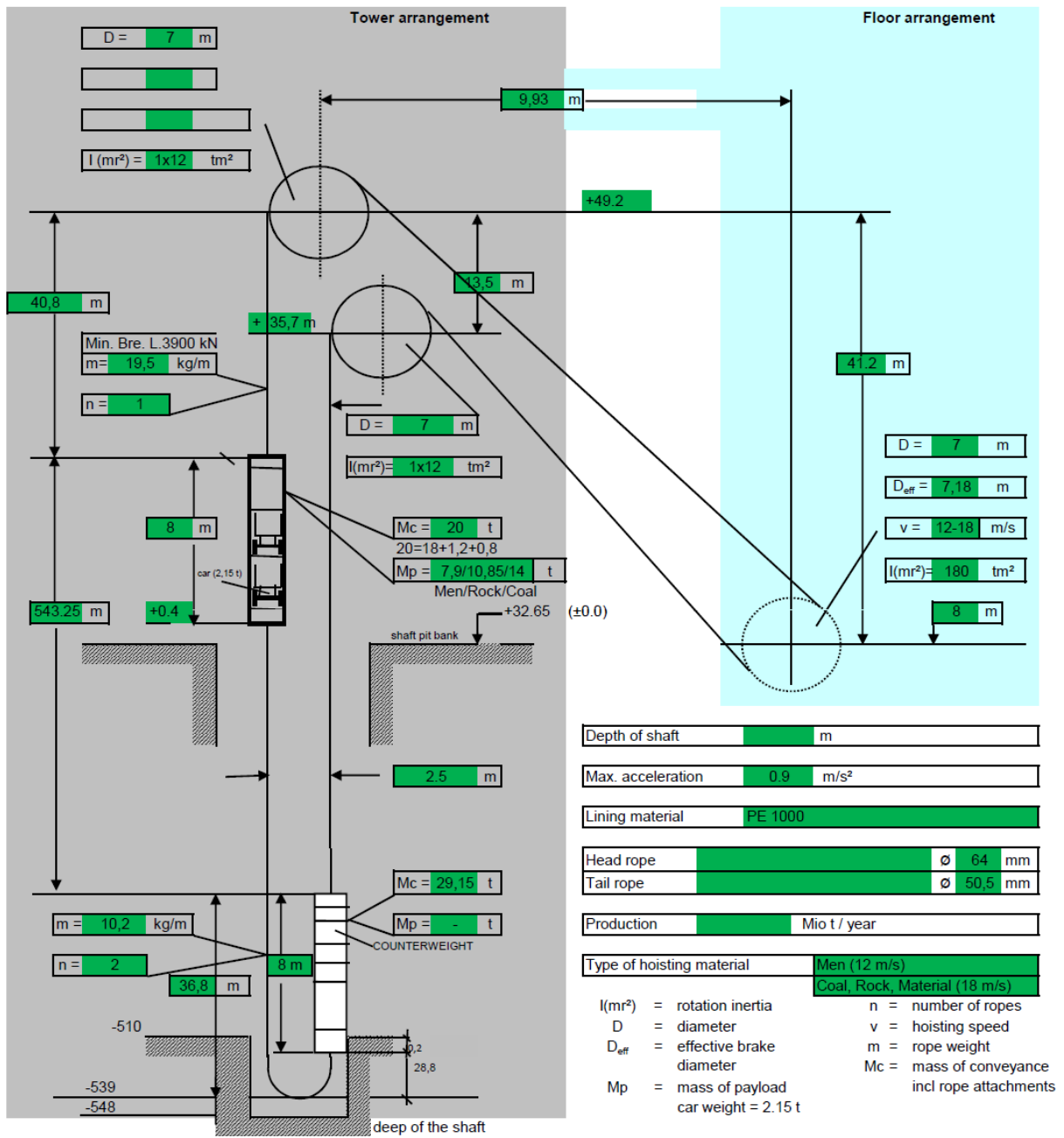

Figure 9. Shaft No.3 Cage-Counterweight Hoisting Parameters

2.2. GALLERIES

Project field encloses levels lower than -400 in Amasra A field and the entire Amasra B field. According to existing data, HEMA decided to divide the license field into three production field. These fields are named as follows:

- East Production Block (First Operation Field)
- West Production Block (Second Operation Field)
- Southeast Production Block (Third Operation Field)

Mechanized systems will be used for production of these blocks.

2.2.1. MAIN ROADWAYS OF EAST PRODUCTION BLOCK

East Block has a 4,2 km² area. In this area, based on the seam correlation studies of Westphalia-C-aged four coal seams between -410 and -530 levels, app. 45 million ton coal have been planned to be produced via production panels and development works.

In order to produce this reserve, main roadways from Shaft No.1 and Shaft No.3 and horizontal and inclined galleries at production Blocks will be headed (Table 7).

Shaft No.3 and -410 main roadway will serve as return air way. Shaft No.1 and -510 main roadway will serve as intake air way for East and West Blocks during development works and as intake air during production. Shaft No.2 and Shaft No.1 will also be used as for man and material transport to production areas.

A belt conveyor gallery, with 24 m² section, to be used for coal haulage will be headed from Shaft No.1 at -510 level.

No.1703, 1704, 1602 gallery will serve fresh air to the production panels. Overall gallery timeline is given as (Appendix-8).

Table 7. Galleries of East Production Block

Gallery No	Level	Length (m)	Section (m ²)	Dip (°)
3603	-410	2641 (1539m completed)	24	0
3705	-510	1023 (completed)	24	0
Connection Gallery		59 (completed)	24	
1703	-506	1325	24	0
1704	-500,46	53	24	0
1705	-500,46	46	24	0
1702 1706 1707	-500,46/-530,03	391	24	4
3703	-510	158 (completed)	24	0
3704	-510	1376 (991m completed)	24	0
3602	-402,00/-505,00	477 (269m completed)	24	11-14
Connection Gallery		107 (completed)	24	0
1602	-403,70/-530	1414	24	5
1612	-403,70/-530	1454	24	5
2703	-510	1156	24	0
TOTAL		11678		

2.2.2. GALLERIES OF WEST PRODUCTION BLOCK

West Block has an 3,7 km² area. In this area, based on the seam correlation studies of Westphalia-A-aged 7 coal seams between -250 and -800 levels, app. 37 million ton coal have been planned to be produced via production panels and development works.

In order to produce this reserve, main roadways from Shaft No.2, horizontal and inclined galleries from the surface will be headed (Table 8).

-510 and -610 main roadways will be headed in West Block. -510 main roadway will serve as intake air way for planned West Block and for man/material transportation to production panels. -610 main roadway will serve as intake air way for Southeast Block. Inclined galleries will be used for man/material transportation and clean air distribution to production panels and for coal transport. Horizontal galleries will serve as return air way. Also see Appendix-8.

Table 8. Galleries of West Production Block

Gallery No	Level	Length (m)	Section (m²)	Dip (°)
2703	-510	1131 (54m completed)	24	0
2502	-510/-349	695	24	14
2412	-507/-277	931	24	17
2402	-507/-260	859	24	17
3053	+90	461	24	0
3052	+90/+30	402 (completed)	24	0-14
2202	+30/-349	1495 (479m completed)	24	14
3054	+90	690 (completed)	18	0
2053	+90	138 (completed)	18	0
2252	+90/-213 -213/-227	1922 (100m completed)	18	16
TOTAL		8724		

2.2.3. GALLERIES OF SOUTHEAST PRODUCTION BLOCK

Southeast Block has a 4,1 km² area. In this area, based on the seam correlation studies of Westphalia-C-aged two coal seams between -680 and -890 levels, app. 21 million ton coal have been planned to be produced via production panels and development works.

Galleries that will be headed from Shaft No.2 will be used to send intake air to the production panels and man-material transportation (Table 9). See Appendix-8 for details of gallery headings.

Table 9. Galleries of Southeast Production Block

Gallery No	Level	Length (m)	Section (m²)	Dip (°)
2712	-505/-607	477	24	14
2803	-610	1061	24	0
4803	-614,50	1669	24	0
4802	-614,50/-890	1138	24	14
4904	-890,50	50	24	0

4905	-890	1069	24	0
4703	-513	1398	24	0
4702	-513/-614,50	419	24	14
4803	-614,50	50	24	0
4812	-614,50/-890	1138	24	14
4903	-890	1069	24	0
2702	-607/-509	892	24	14
2705	-509	782	24	0
2702	-607/-720 -720/-607	702	24	14
TOTAL		11914		

In total, including shaft stations and water sumps, 34894m gallery will be headed.

2.2.4. MAIN ROADWAY LEVELS

- Areas suitable for production at East Block are dipped to southeast as seen on contour maps. Dip of seams is between 6°-12° (also see Appendix-1, Appendix-2, Appendix-3, Appendix-4, Appendix-5, Appendix-6 and Appendix-7).
- Areas suitable for production at West Block are dipped to southeast as seen on contour maps Dip of seams is between 15°-20° (also see Appendix-1, Appendix-2, Appendix-3, Appendix-4, Appendix-5, Appendix-6, and Appendix-7).
- Areas suitable for production at Southeast Block are dipped to southeast as seen on contour maps. Dip of seams is between 10°-15° (also see Appendix-2, Appendix-3).
- Due to low dipping of coal seams, spacing between levels are chosen 100 meter.

Main levels are; at East Block: -410 and -510 levels, at West Block: -325, -410 and -510 levels and at Southeast Block: -510, -610 and -890 levels.

2.2.5. MAIN ROADWAYS

-410 Level Galleries:

No.3603 gallery from Shaft No.3 -410 level will be serve as return air way. This gallery will be connected to No.3705 gallery, from Shaft No.1, with inclined gallery No.3602. The ventilation system after developments will be applied as described in Article 2.2.1.

-510 Level Galleries:

During East Block production period, 24 m² section No. 3704 and 1703 galleries, that connect to intake air Shaft No.1, will be used as fresh air way. At the same time, it will be used for personnel and material transportation to the faces (Appendix-1).

During West Block production period, 24 m² section No. 2703 and 2803 gallery, that connects to intake air Shaft No. 2, will be used as fresh air way. Whilst West Block seam WA500, WA600 and WA700 are being produced, No. 2703 gallery will be return air way.

During Southeast Block production period, 24 m² section No. 4703 gallery, that connects to return air Shaft No. 2, will be return air way. At the same time, it will be used for coal transportation from faces (Appendix-5, Appendix-1 and Appendix-2).

-610 Level Galleries:

During Southeast Block production period, 24 m² section No. 4703 gallery at level -610, that connects to intake air Shaft No. 2 will serve as intake air way. At the same time, it will be used for personnel and material transportation to the faces (Appendix-2 and Appendix-3).

2.2.6. GALLERY CROSS SECTIONS

In total 34894m main transportation and ventilation galleries (B24 and B18) and gateways (B22 and B18) will be headed. Support system selection and calculations have been done for galleries and gateways.

Primarily, support study has been made for main development roads including -410 and -510 level galleries, connection roads from Shafts No 1. and No 3.

2.3. CROSS CUT GALLERIES AND INTERVALS

- Average face length in West Block is 220 meter, in East Block is 204 meter and in Southeast Block is 207 -242meter.
- Cross-cuts will be headed according to serve for ventilation, material, men and production purposes. Minimum length of gateways will be 600-2200 meter.
- It's been estimated that fully mechanized retreat longwall mining method will be suitable for secure gateways.

2.4. DEVELOPMENT TIMELINES OF SHAFTS AND GALLERIES

Development timelines of shafts and galleries is given in Appendix-8.

2.5. GATEWAYS CROSS SECTIONS

During development process, 236706 meters in total will be driven as gateways. From development works app. 5,6 million ton coal will be extracted. Gateways are planned as 600-2200 m for mechanized panels.

Dismantling period of face is planned as 250 days for 2200 m panel length, average 2 meter seam and 8,8 m advance per day. Maingates will be used as tailgate of the next panel. Due to this situation, maingates will serve 295 more days including installation period.

2.6. GEOTECHNICAL ANALYSIS OF MINE AREA

2.6.1. SEASMICITY OF BARTIN - AMASRA

Bartın-Amasra is located in I. and II. Degree earthquake zones according to Earthquake Zoning Map of Turkey that was published by ministry of public works and settlement in 1996 (Figure 10).

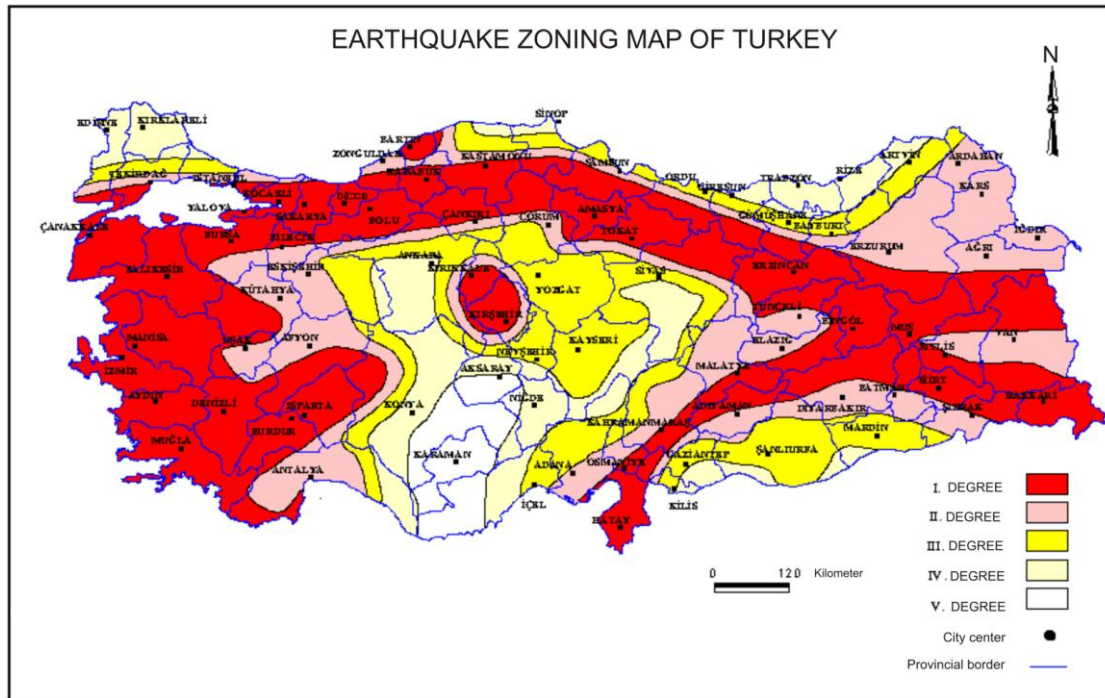

Figure 10. Earthquake Zoning Map of Turkey

This map prepared by the Ministry of Public Works and Settlement considering the latest knowledge and approved by the Government of Turkey and published in 1996. The earthquake zones determined by using the acceleration contour map that has calculated with the probabilistic method. It assumes that a normal construction, which has 50 years of economical life, may not be exposed larger than these expected maximum acceleration values with 90% probability. For the important constructions or buildings that have longer economical life, maximum acceleration values should be calculated.

"Specifications for structures to be built in the disaster areas" refers to this map for the calculation of acceleration values that will effect the construction.

Earthquake zones of Turkey classified as fallow due to expected acceleration values

1st degree earthquake zone: more than 0.4g

2nd degree earthquake zone: between 0.3g - 0.4g

3rd degree earthquake zone: between 0.2g - 0.3g

4th degree earthquake zone: between 0.2g - 0.1g

5th degree earthquake zone: less than 0.1g

This map has been prepared by using the report named "A Seismic Zones Map of Turkey Derived from Recent Data" which was prepared by Polat Gülkan, Ali Koçyiğit, M.Semih Yücemen, Vedat Doyuran and Nesrin Başöz (METU Civil Engineering Dept. Earthquake Engineering Research Center) and presented to the Ministry of Public Works and Settlement, General Directorate of Disaster Affairs as a final report of project 92-03-03-18 in January 1993.

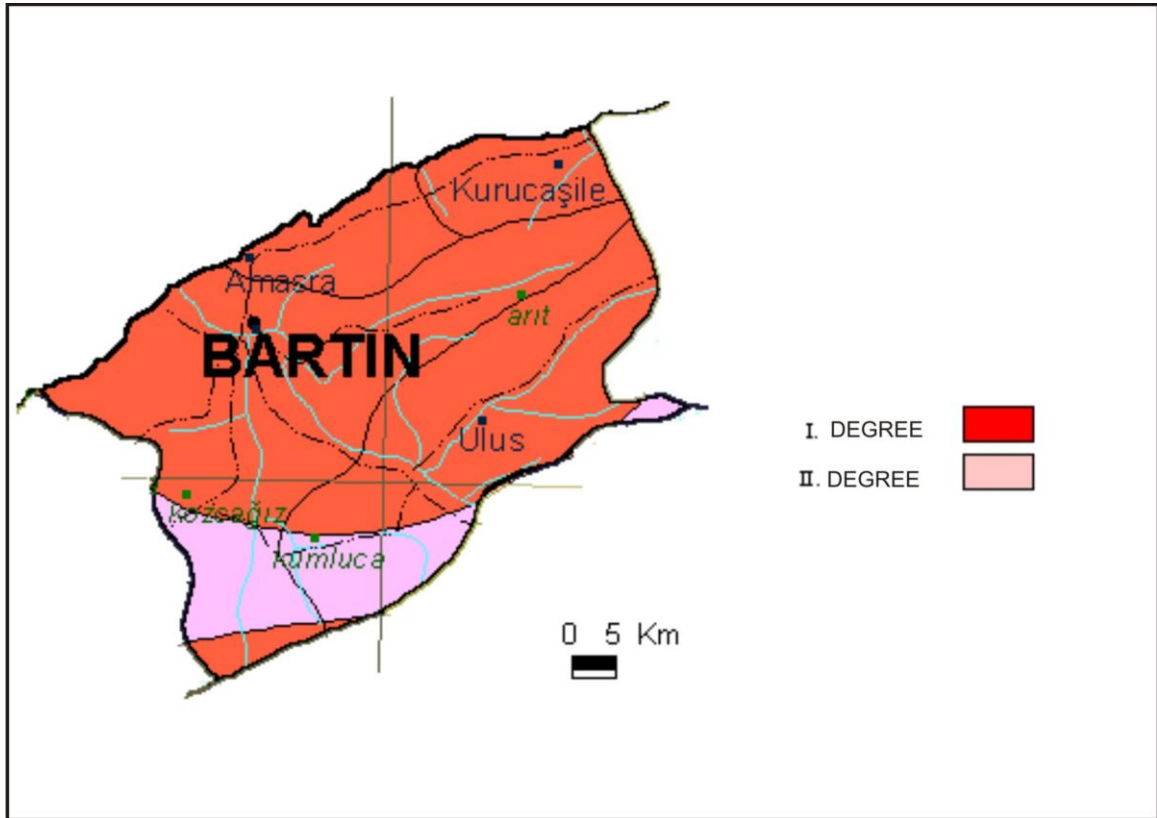

Figure 11. Earthquake Zoning Map of Bartın

Seismicity of Bartın is considered as a effectiness of the earthquakes, which are due to faults around of Bartın, and the earthquakes that occur on north Anatolian fault zone.

The earthquakes, which will occur circular area with 150 km radius and located on city center of Bartın, with richter scale 6 and more than 6, are considered as earthquakes with damage for Bartın. In this circular influence area, the earthquakes that has occurred instrumental time (since 1900) and $M \geq 2$ are shown on Table 10. Also the earthquakes, which have occurred in provincial border of Bartın, are shown in Table 10.

Table 10. The earthquakes that have occurred in provincial border of Bartın and $M \geq 2$ between 1990 and 2008

DATE	TIME (GMT)	LATITUDE (K)	LONGITUDE (D)	DEPTH (Km)	MAGNİTÜDE Md	LOCATION
02.04.1991	13:38.6	41.5400	32.5300	1	2.9	
13.04.1991	39:41.9	41.3400	32.3200	5	2.6	
14.04.1991	14:55.2	41.7000	32.3900	15	3.4	
26.03.1992	22:44.0	41.4100	32.4100	10	3.6	
18.05.1994	22:45.5	41.8200	32.4400	1	3.7	
01.09.1994	50:40.7	41.7600	32.5500	1	3.2	
01.09.1994	53:13.6	41.8300	32.4500	1	3.5	
01.11.1994	42:32.5	41.7400	32.4600	1	3.3	
28.07.1998	30:29.3	41.6900	32.4600	1.9	3.2	Bartın-Karabük
28.11.1999	57:52.0	41.7000	32.4500	5.3	2.8	Black Sea
22.10.2002	48:57.8	41.6500	32.6300	9.5	3.1	BARTIN
12.08.2003	05:38.3	41.3400	32.0900	11	3.8	Devrek-ZONGULDAK
27.11.2003	52:06.1	41.7000	32.5800	5.4	3.1	Ulus-BARTIN
27.07.2004	47:28.1	41.8130	32.2015	18.5	2.7	Merkez-SİNOP
13.08.2004	06:07.1	41.7203	32.4104	10.2	3.0	Amasra-BARTIN

12.09.2004	49:21.1	41.7769	32.4891	8.4	3.0	Amasra-BARTIN
18.10.2004	23:28.2	41.6418	32.5005	1	3.3	Merkez-BARTIN
05.11.2004	31:05.7	41.6900	32.6931	2.9	3.2	Merkez-BARTIN
26.03.2005	19:51.5	41.5223	32.7574	15	2.7	Ulus-BARTIN
04.05.2005	56:48.0	41.8061	32.3525	5.9	2.7	Karadeniz
10.05.2005	28:32.4	41.5403	32.8201	2	2.7	Eflani-KARABÜK
08.06.2005	16:32.1	41.6509	32.2963	4.3	2.9	Merkez-BARTIN
14.06.2005	01:34.7	41.7675	32.5831	12.4	3.3	Kurucaşile-BARTIN
14.06.2005	17:38.4	41.8044	32.6451	12.6	2.7	Kurucaşile-BARTIN
06.07.2005	35:47.3	41.5752	32.4849	17.5	2.9	Merkez-BARTIN
19.08.2005	59:58.5	41.3241	32.7136	4.8	2.8	Safranbolu-KARABÜK
08.09.2005	49:01.8	41.3481	32.6890	2.4	2.9	Safranbolu-KARABÜK
16.10.2005	17:12.5	41.3768	32.6722	5.3	2.9	Safranbolu-KARABÜK
24.11.2005	43:49.9	41.3361	32.7192	3.6	3.0	Safranbolu-KARABÜK
12.04.2006	02:09.4	41.3080	32.3571	4	2.8	Yenice-KARABÜK
20.04.2006	10:21.0	41.7507	32.5209	10.3	3.9	Amasra-BARTIN
20.04.2006	38:41.9	41.5325	32.6950	2.4	2.9	Ulus-Bartın
20.04.2006	50:21.1	41.7567	32.5115	2.2	3.3	Amasra-Bartın
20.04.2006	35:06.0	41.6505	32.5260	2.6	3.1	Merkez-Bartın
10.05.2006	23:43.1	41.3616	32.6894	2.7	2.9	Safranbolu-KARABÜK
18.05.2006	29:57.6	41.6901	32.3305	3	2.6	Amasra-BARTIN
25.07.2006	28:11.8	41.7738	32.4559	3.2	2.9	Amasra-BARTIN
02.08.2006	30:57.9	41.3557	32.6679	3.7	2.7	Safranbolu-KARABÜK
04.09.2006	42:50.7	41.3343	32.7309	3.5	3.0	Safranbolu-KARABÜK
23.09.2006	10:17.7	41.6706	32.6910	2	3.2	Ulus-BARTIN
04.11.2006	23:33.1	41.7108	32.4917	2.1	3.2	Amasra-BARTIN
24.07.2007	46:50.0	41.6822	32.6465	7	3.0	MERKEZ-BARTIN
03.04.2008	03:38.9	41.3125	32.7440	7	2.9	SAFRANBOLU-KARABUK
11.04.2008	45:38.1	41.3823	32.7445	7	3.1	SAFRANBOLU-KARABUK

As it is known, North Anatolian Fault Zone (NAFZ) is one of the major fault system of Turkey. Bartın province is approximately 100 km away from this zone. In Bartın province and its surrounding area (in 75 km radius of Bartın city center) 9 historic earthquakes have been known. 45 earthquakes have been recorded instrumentally since their recording started. An earthquake in 6.4 magnitude, which occurred in 1968 in Amasra town stands out. An earthquake hazard map was prepared on the basis of calculated intensity and acceleration values of an earthquake which is likely to occur on NAFZ. According to resulted values, a probable earthquake in 6.4 magnitude taking place in near sea may give 9 as intensity value for Amasra and 8 for Bartın city center. In city center, 200 microtremor measurements were carried out.

According to this study, intensity values of structures built on soft geological units may increase exponentially.

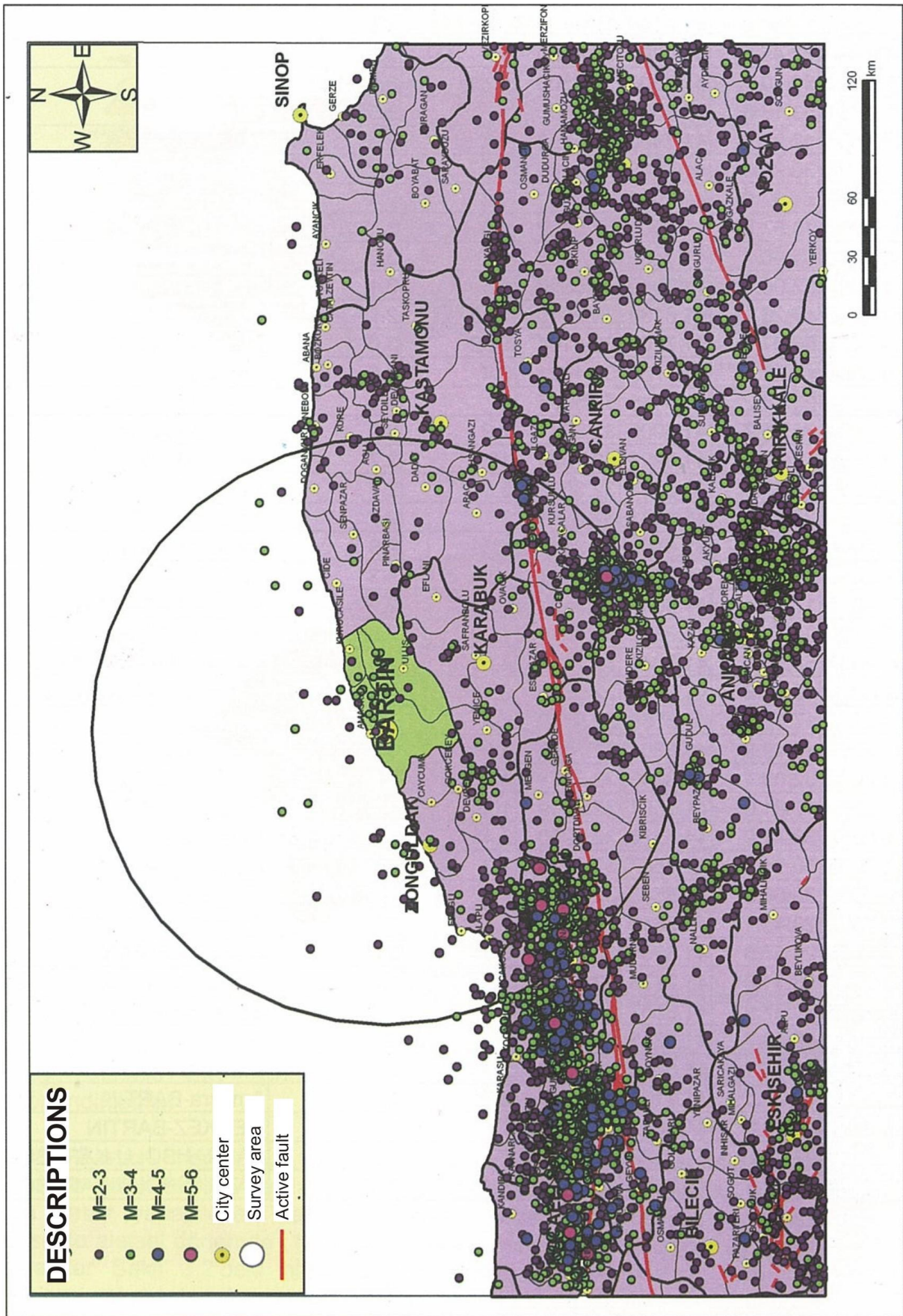

Figure 12. The earthquakes that have occurred in survey area and $M \geq 2$

2.6.2. ROCK STABILITY INDEX

Rock stability index is priority while calculating gallery support design. Rock stability index has been calculated from SIKORA-KIDYBINSKI assumption:

$$Sg = \bar{\sigma}_{ef} / \gamma * H * k * a * b$$

Sg = Stability index of formations

$\bar{\sigma}_{ef}$ = In-situ compressive strength of formations

For sandstone and conglomerate-----33 MPa (3300 t/m²)

For clayey shale-----12 MPa (1200 t/m²)

γ = Density of formations, t/m³ ~ average 2,6 t/m³

H = Average depth, m ~ 700,00 m

k = Strain accumulation factor for gallery region,

k = 1,5 for cross cut galleries which away from production,

k = 2,5 for gateways close to production

a = Gallery size factor

For B-24 a = 3,25

For B-18 a = 2,00

For B-10 a = 1,25

b = Rock failure factor

For galleries b=1, For gateways b=1,8

2.6.3. SUPPORT LOAD

Support loads are being calculated according to EVERLING formula.

$$P_t = \alpha * \gamma * l$$

P_t = Roof Load for support, t/m²

α = Roof Load factor

sandstone0,25

clayey shale0,50

l = Gallery width, m

γ = Density of roof rock

Support load has been calculated according to the above formulation and for various gallery types and formation

2.6.4. TH SUPPORT SYSTEM

In order to use long-life galleries, to suppress convergence, yielding support (TH Profile) has been chosen. Due to various formation conditions there are several roof load values. Thus, TH spacing distance varies.

$$a = 2 \cdot F_{\check{c}} / P \cdot d$$

a = Distance between yielding support, m

$F_{\check{c}}$ = Geçme bağ elemanlarının çözülme yükü, 15 ton

P = Support load capacity 15-20 t/m²

d = Gallery width, m

2.6.5. SHOTCRETE SUPPORT SYSTEM

According to geotachnical data and geomechanical speficiation of formation; empirical shotcrete thickness table is given below as Table 11:

Table 11. Secure shotcrete thickness calculation

Formation Condition R.Q.D. %		Roof Coating Thickness cm	Side Wall Thickness cm
Excellent	>75	7 - 8	> 5
Fair	75 - 50	10 - 12	>5
Poor	50 - 25	>15	7 - 8
Very Poor	< 25	Shotcrete + Rigid support must be used.	

Secure shotcrete thickness according to Rabcewicz assumption based on B-18 section gallery
r = 2,12 meter:

$$T_e = 4,33 \cdot (r \cdot p / \sigma_b)$$

$$T_e = 4,33 \cdot (212 \text{ cm} \cdot 0,768 \text{ kg/cm}^2 / 140 \text{ kg/cm}^2) = 5,03 \text{ cm}$$

r = gallery radius (cm)

p = pressure affecting gallery shotcrete (kg/cm²)

T = shotcrete thickness (cm)

σ_b = shotcrete sliding strength and pressure strength (kğ/cm²) cylinder strength values

B 160 concrete: 140 kg/cm²

B 225 concrete: 195 kg/cm²

B 300 concrete: 240 kg/cm²

According to Heuer assumption;

- Max. Effect over coating surface

$$t_m = \alpha \cdot p \cdot r$$

$$t_m = 1,4 \cdot 7,68 \text{ t/m}^2 \cdot 2,12 = 22,79 \text{ t/m}$$

- Load capacity of coating unit length

$$t_k = \varphi \cdot (0,85 \cdot \sigma_b) \cdot T_e$$

$$t_k = 0,65 \cdot (0,85 \cdot 140 \text{ kğ/cm}^2) \cdot 9,8 = 758,03 \text{ kğ/cm}$$

- Shotcrete thickness

$$T = \alpha / (0,85 \cdot \varphi) \cdot (p \cdot r) / \sigma_b$$

$$T = 1,4 / (0,85 \cdot 0,65) \cdot (0,768 \text{ kğ/cm}^2 \cdot 212 \text{ cm}) / 140 \text{ kğ/cm}^2$$

$$T = 2,5 \cdot 1,16 \text{ cm} = 2,9 \text{ cm}$$

- Secure shotcrete thickness

$$T_e = F \cdot (p \cdot r / \sigma_b) + 7,5$$

$$T_e = 2,0 \cdot (0,768 \text{ kğ/cm}^2 \cdot 212 \text{ cm} / 140 \text{ kğ/cm}^2) + 7,5$$

$$T_e = 9,8 \text{ cm}$$

α = load factor under normal conditions $\alpha = 1,4$

ϕ = eğilme için basınç direnci azaltma faktörü $\phi=0,65$
F = safety factor *on temporary coating=2 *on shotcrete=2 – 3,

Due to RQD values varies between 70-80 at Hema-5 drillhole levels -416,00 and -422,90, shotcrete thickness should be 7-8 cm on roof and 5 cm on side walls. Especially for coarse-grained sandstone with RQD value of 75%, shotcrete must have 8-10 cm thickness on roof and 5 cm thickness on side walls.

B–24 Galleries: For sandstone – conglomerate formation with 8–17 t/m² load capacity, TH-34 profile with 1,5 m spacing must be used with 5-8 cm shotcrete thickness. For clayey shale formation with 17–34 t/m² load capacity, same profile type must be used together with 10-12 cm shotcrete thickness.

B–18 Galleries: For sandstone: Same profile type with load capacity 8–16 t/m² must be used with 8 cm shotcrete on roof and 5 cm shotcrete on side walls. For clayey shale formation with load capacity of 16–31 t/m², shotcrete thickness must be 12 cm on roof and 10 cm on side walls

2.6.6. SUPPORT CHOICE OF MAIN ROADWAYS

According to calculation above, support choice have been made.

Technical drawing of B24 gallery cross section is given in Figure 13.

- Gallery section F=24 m²
- Depth H=700,00 m
- Formation Clayey Shale-Sandstone–Conglomerate
- Unconfined compressive strength 68-100 MPa
- In-situ compressive strength 12-33 Mpa
- Rock stability index 0,33-0,91
- Roof Load 0,85-0,42 kg/cm²
- Support Load Capacity 1,70–3,40 kg/cm²- 0,84–1,68 kg/cm²
- Support System TH+shotcrete-TH+shotcrete
- Profil type (spacing) 13-27 cm-27-54 cm

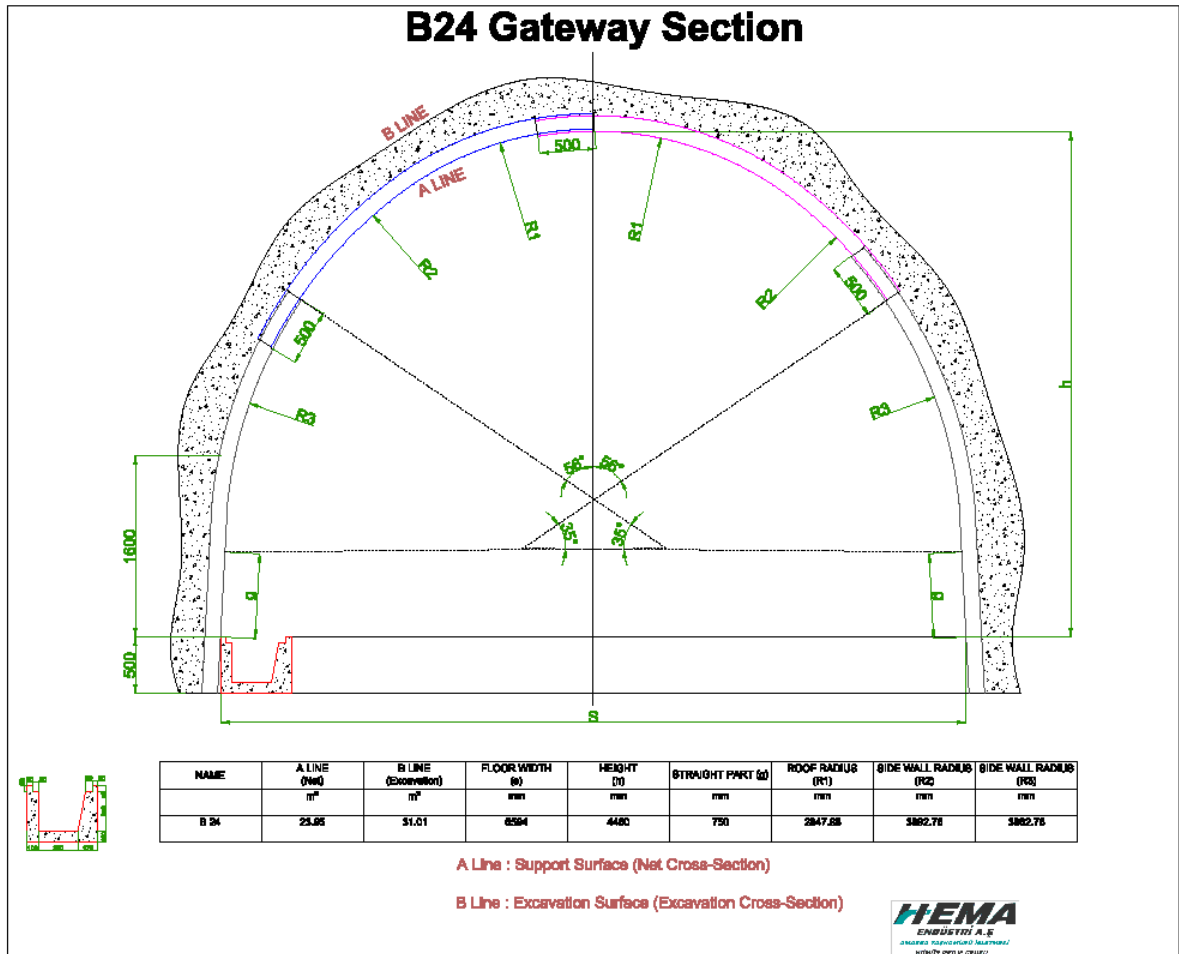

Figure 13. B24 Gallery (Net Section 24 m²)

Technical drawing of B18 gallery cross section is given in Figure 14.

- Gallery section F=18 m²
- Depth H=700,00 m
- Formation Clayey shale-Sandstone-Conglomerate
- Unconfined Compressive Strength 68-100 MPa
- In-situ Compressive Strength 12-33 MPa
- Rock Stability Index 0,14-0,37
- Roof Load 0,78- 0,39 kg/cm²
- Support Load Capacity 1,56-3,12 kg/cm² - 0,78-1,56 kg/cm²
- Support System Rigid+shotcrete - Rigid+shotcrete
- Profil type (spacing) 16-32 cm- 32-64 cm

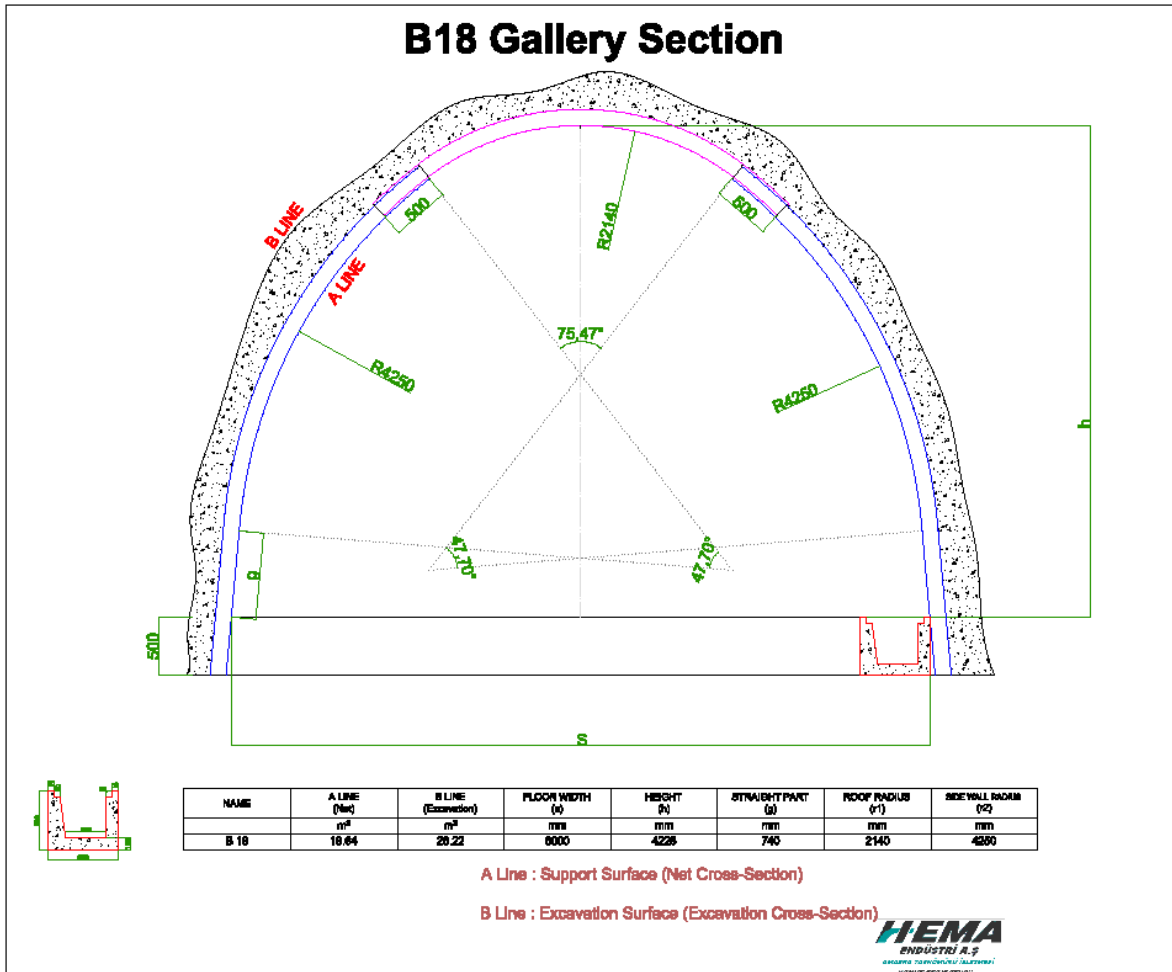

Figure 14. B18 Gallery (Net Section 18 m²)

2.6.7. SUPPORT TYPE COMBINATIONS

In order to use long-life galleries, to suppress convergence, yielding support (TH Profile) has been chosen. Due to various formation conditions of galleries that will be driven in two different section, there are different roof load values. According to roof load values, three different support type has been chosen (Figure 15, Figure 16, Figure 17).

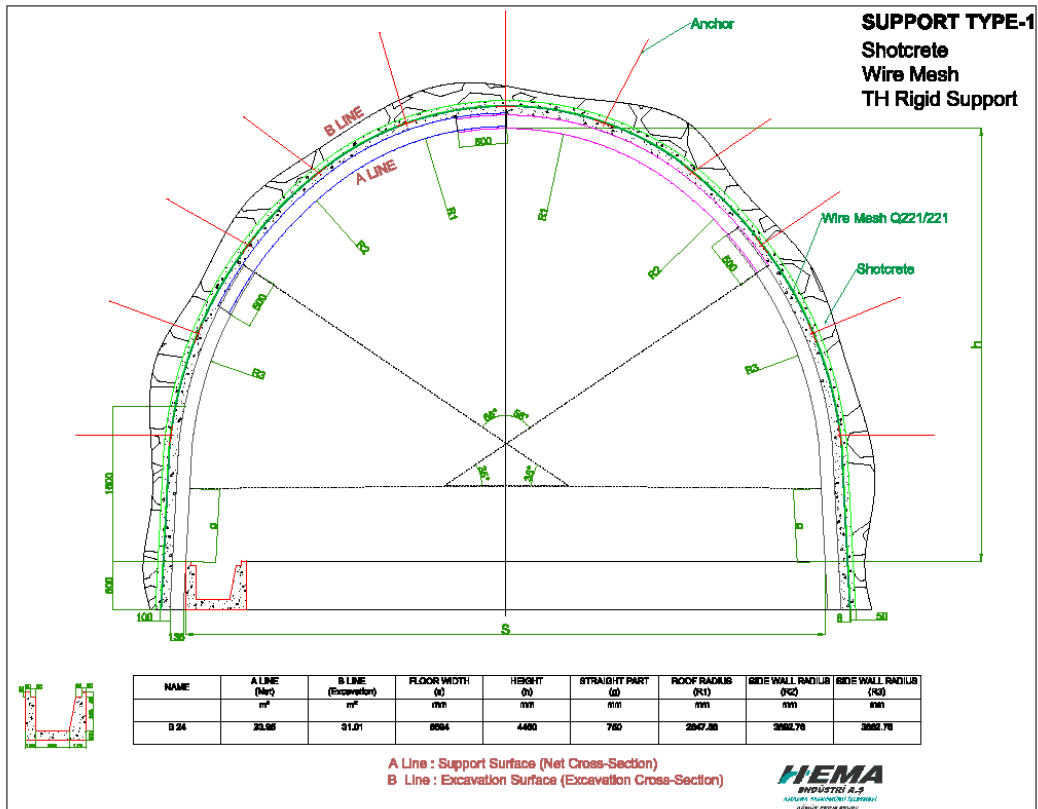

Figure 15. Support Type-1

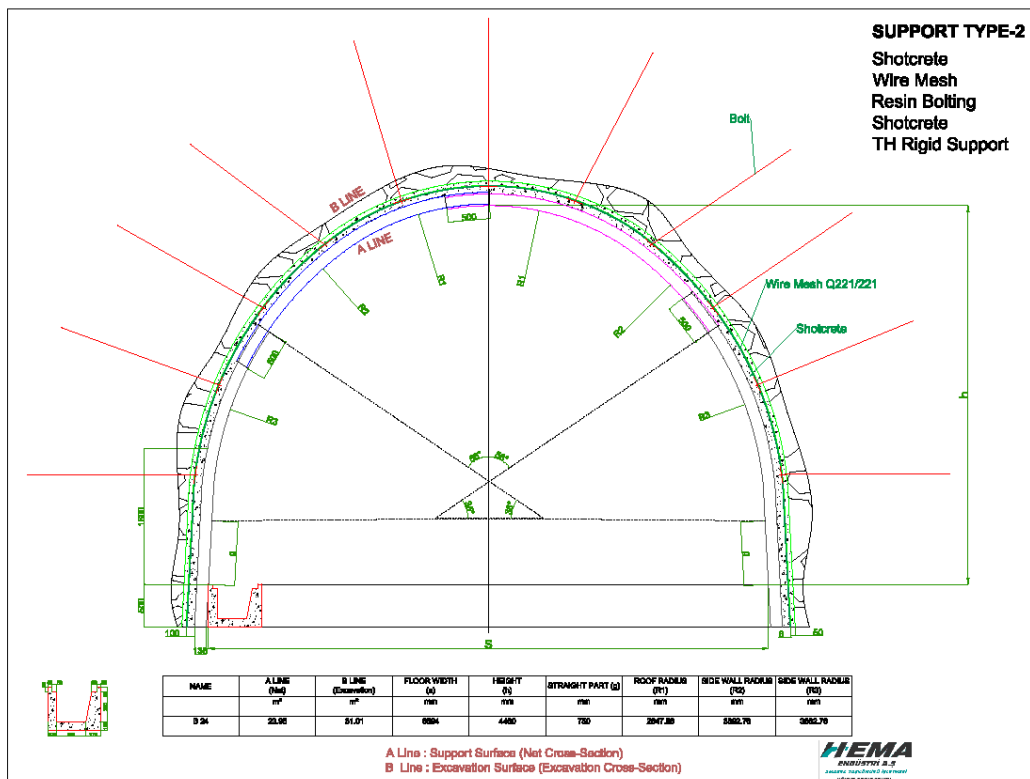

Figure 16. Support Type-2

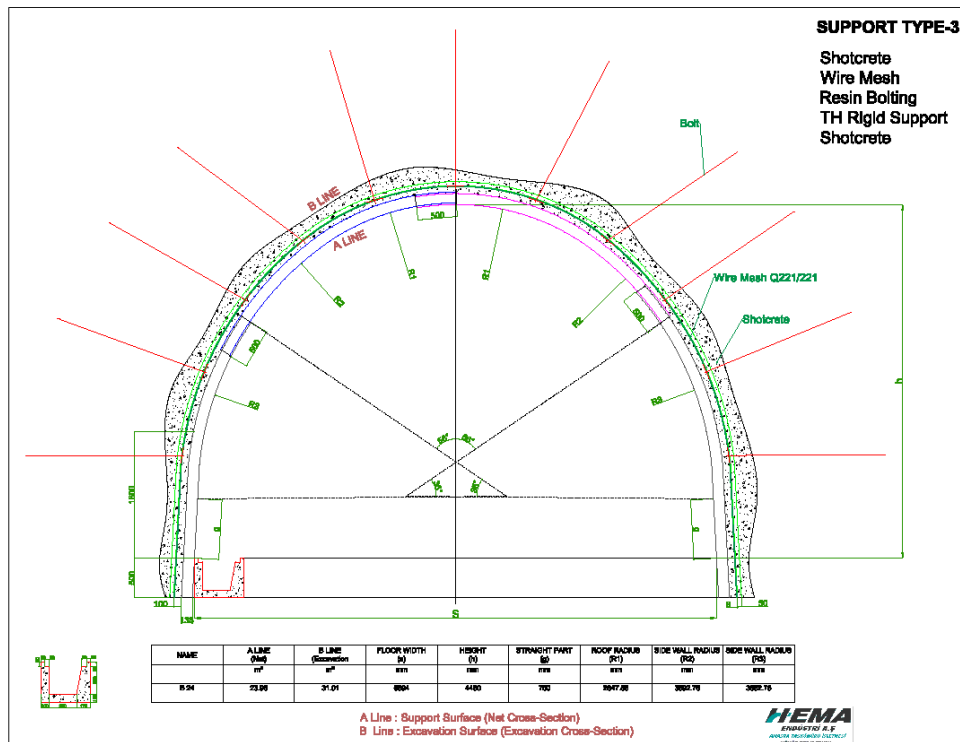

Figure 17. Support Type-3

2.6.8. SUPPORT STANDARDIZATION

- In order to use long-life galleries, to suppress convergence, yielding support (TH Profile) has been chosen.
- In good formation -> Roof Load: 8 ton/m²,
- In fair formation -> Roof Load: 12 ton/m²
- In poor formation -> Roof Load: 21 ton/m². According to these different roof load data, three different support type has been chosen.
- It's been planning to use 1,5 m spacing between TH support units. This will cause roof load to increase (12 ton/m²). This load value will make TH support insufficient. Therefore, shotcrete on side walls will be 3-5 cm, on roof will be 5-7 cm with rock bolt systems.
- In poor formations where overload is possible for roof loads (21 ton/m²), it's clear that TH support together with rock bolts and one layer shotcrete will be insufficient. Therefore, a second layer of shotcrete will be applied. On side walls shotcrete thickness will be 6-8 cm, and on roof 10-12 cm.

2.6.9. GATEWAY SUPPORT STUDY

On gateways, TH units (34 kg/m) spacing must be 0,65 meter. According to overloading, spacing must be decreased and additional rock bolts must be used.

2.6.10. SUPPORT CHOICE OF GATEWAYS

According to calculations above, support choice have been made.

B24 Gateway (Net section 24 m²) technical drawing is given in Figure 13.

- Gallery section F=24 m²
- Depth H=800,00 m
- Formation Clayey Shale
- Unconfined compressive strength 68 MPa
- In-situ compressive strength 12 MPa
- Rock stability index 0,0530
- Estimated convergence % 40
- Support load capacity 0,7–1,0 kg/cm²
- Yielding Load ... 15 ton
- Roof Load0,63 kg/cm²
- Support System TH
- Support Spacing 0,65 m
- Profil type 34 kg/m

Evaluated from sizing nomogram.

2.6.11. ROOF LOAD CALCULATIONS AT PRODUCTION FACE

In order to estimate the roof load and determine the support capacity, density for mechanized longwall shield's, load calculations have been done as follows:

2.6.11.1. SUPPORT DENSITY

$$F_H = (0,6) \cdot r \cdot H \quad [\text{ton/m}^2] \quad (1)$$

F_H : Support Density [ton/m²]

r : Rock Volume Weight [ton/m³]

H : Mining Depth [m]

$$P_s = \frac{n \cdot M}{(K_p - 1)} \cdot \gamma \cdot 10 \quad [\text{kN/m}^2] \quad (2)$$

P_s : Support Density [kN/m²]

γ : Rock Volume Weight [ton/m³]

n : Unbalance Pressure Factor -> 2,5

M : Maximum Mining Height [m]

K_p : Swelling Factor -> 1,35

According to equation (2);

$$P_s = \frac{n \cdot M}{(K_p - 1)} \cdot \gamma \cdot 10$$

For thin seam;

M: 2,0m

$$P_s = \frac{(2,5) \cdot (2,0)}{(0,35)} \cdot (2,6) \cdot 10$$

$$P_s = 371,4 \text{ [kN/m}^2\text{]}$$

For high seam;

M: 4,0m

$$P_s = \frac{(2,5) \cdot (4,0)}{(0,35)} \cdot (2,6) \cdot 10$$

$$P_s = 742,9 \text{ [kN/m}^2\text{]}$$

2.6.11.2. YIELD LOAD

$$Q_s = P_s \cdot (B_c \cdot S_c) \quad \text{[kN]} \quad (3)$$

Q_s : Yield Load [kN]

P_s : Support Density [kN/m²]

B_c : Length of Supporting Area [m]

S_c : Centre Spacing of Support [m]

Intersection Angle of Legs -> 13°

$\frac{Q_s}{\cos 13}$: Minimum Yield Load [kN]

According to equation (3);

B_c : 5,0 [m]

S_c : 1,5 [m]

For thin seam;

$$Q_s = P_s \cdot (B_c \cdot S_c)$$

$$Q_s = (371,4) \cdot (5,0) \cdot (1,5)$$

$$Q_s = 2786 \text{ [kN]}$$

For high seam;

$$Q_s = P_s \cdot (B_c \cdot S_c)$$

$$Q_s = (742,9) \cdot (5,0) \cdot (1,5)$$

$$Q_s = 5572 \text{ [kN]}$$

2.6.11.3. SAFE LOAD

$$P = n \cdot r \cdot H \cdot 10 \quad \text{[kN/m}^2\text{]} \quad (4)$$

P : Load [kN/m²]

n : factor -> 5-10

r : Rock Volume Weight [ton/m³]

H : Maximum Mining Height [m]

According to equation (4);

For thin seam;

H: 2,0m

- $P = n \cdot r \cdot H \cdot 10$

$$P = 8 \cdot (2,6) \cdot (2,0) \cdot 10$$

$$P = 416 \text{ [kN/m}^2\text{]}$$

- $Q_s = P_s \cdot (B_c \cdot S_c)$

$$Q_s = 416 \cdot (5,2) \cdot (1,5)$$

$$Q_s = 3120 \text{ kN}$$

Considering hydraulic leg angle as 13° ;
 Minimum Yield Load for thin seam;

$$\frac{Q_s}{\cos 13} = \frac{3120}{0,974} = 3200 \text{ kN}$$

For high seam;
 H: 4,0m

- $P = n \cdot r \cdot H \cdot 10$

$$P = 8 \cdot (2,6) \cdot (4,0) \cdot 10$$

$$P = 832 \text{ [kn/m}^2\text{]}$$

- $Q_s = P_s \cdot (B_c \cdot S_c)$

$$Q_s = 832 \cdot (5,2) \cdot (1,5)$$

$$Q_s = 6240 \text{ kN}$$

Considering hydraulic leg angle as 13° ;
 Minimum Yield Load for thin seam;

$$\frac{Q_s}{\cos 13} = \frac{6240}{0,974} = 6400 \text{ kN}$$

3. PRODUCTION

3.1. PLANNING OF UNDERGROUND PRODUCTION AREAS

Licence field covers an area of 50 km², in 14 km² of which Hema has the right to mine below -400 level and in 35,6km² of which Hema has the right to mine from surface. Mining plan has been prepared for an area (13km²) which lies south of Tuna Fault and this area is divided into three parts namely, East Block, West Block and Southeast Block.

HEMA have designed the mining plan that takes account of the proximity of the coal seams to be mined the likely geotechnical conditions and the need to operate effectively and safely. The production layout is based on utilising a full extraction of the seam without pillars.

Full mechanized production system with shearer loaders/plow and compatible powered support according to conditions will be applied since seam thicknesses vary at production Blocks. Production will be done by drum shearers, that have 0,80 meter cutting depth and 7,29-12,34 meter daily advance capacity, at 207-240 meter length faces where coal thickness is 2,0m. Operation will be done in four shifts of which three are for production and one for maintenance. Shearer loader will produce 6000 ton R.O.M. coal per day and plow will produce 3500 ton R.O.M. coal per day. 13000-15500 ton daily R.O.M. coal production from three full mechanized panels is planned.

HEMA's mining plan, which includes development and production panels layout, ventilation system, electrical distribution, gas drainage, water pumping, roadway dimensions and supports of main and production roadways, coal transportation and material&men haulage systems has been presented to TTK for approval. TTK are the governmental representative organisation regarding mining of hardcoal in Turkey. TTK have all technical expertise know-how and facilities to enable them to check the plans in accordance with Turkish and International norms.

All aspects both underground and surface operations have been approved by TTK.

3.1.1. EAST BLOCK COAL SEAMS AND PRODUCTION PLANNING

Production project covers an area of 4,2km² in East Block. Area of our interest in East Block is the part surrounded by the Central Fault at the west, Tuna Fault at the North, an anomaly at the east and the Fault No.2 at the south. (Figure 18) In this area there are 6 coal seams having recoverable thickness and are said to be Westphalia-B, Westphalia-C and Westphalia-D aged. These seams exist between -400 and -530 levels and are given the names EC100, EC-200, EC300, EC400, EC500 and EC600 from top to the bottom, respectively. EC100 and EC-200 does not extend to all of the license field, but only at west part of East Block. In this area, seams having minimum 0,95m thickness have been assumed to be the recoverable. Correlation studies of Westphalia-A aged seams below -550 level are still on progress and has not been evaluated on current project (Figure 18).

The production method in the part between Fault No.1 and the anomaly will be full-mechanized due to the suitable panel lengths and seam inclinations where EC100 and EC-200 have feasible thicknesses to operate.

In this area, reserve of the full-mechanized panels is app. 45 million ton. Panels where inadequate data and unrecoverable seam thickness occurs is not included to reserve calculations (Appendix-14). These areas will be evaluated during underground operations are being held. Seam inclinations vary between 6° and 12°.

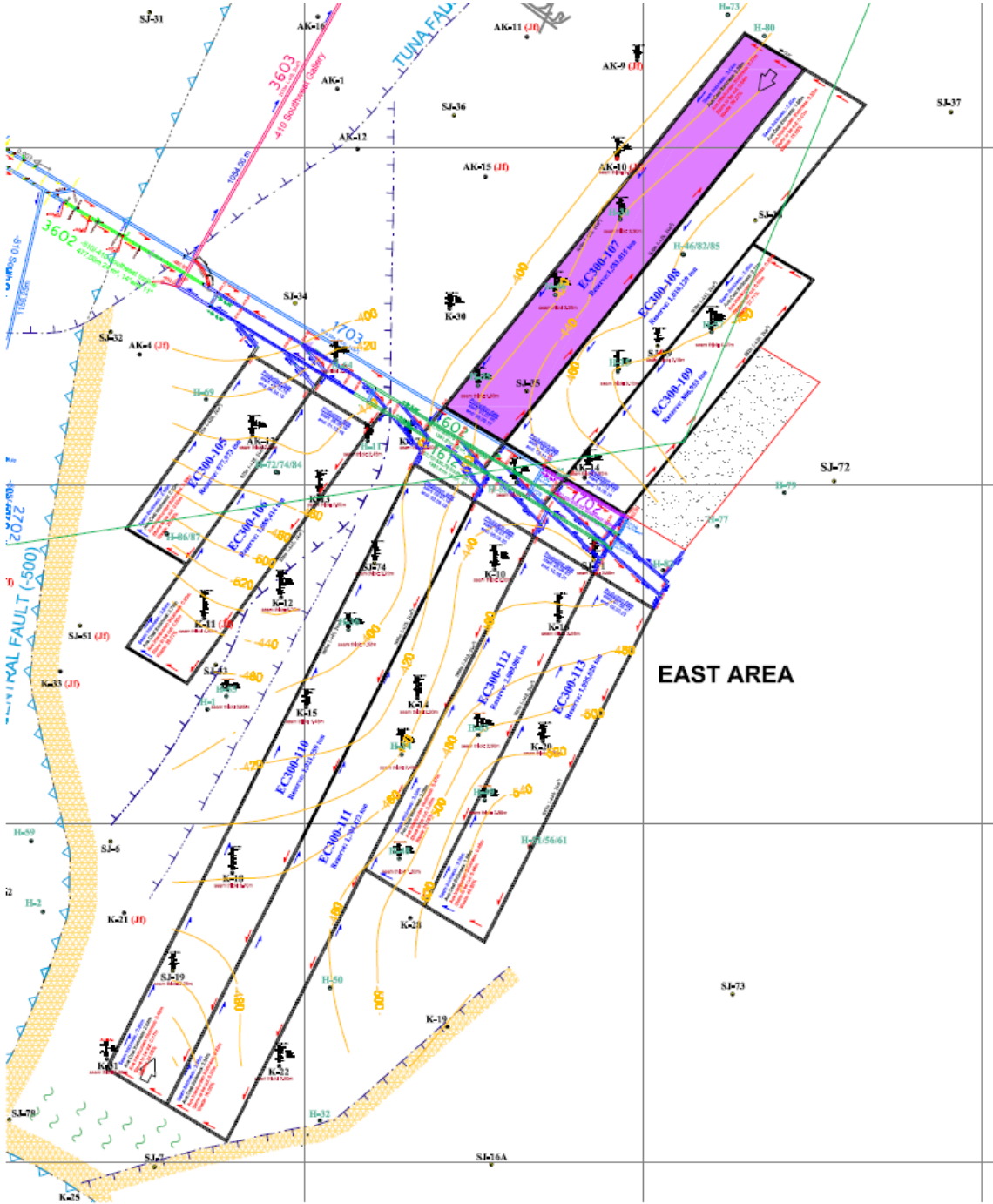

Figure 18. East Production Block

SEAM EC100

Seam thickness varies between 1,25m and 2,03m. There is an interburden in the seam and its thickness varies between 0,10m and 0,60m. Face will be operated between 6° and 12°. Operational height of the face will be from 1,10m to 2,30m due seam thickness and the selected machine. Face width will be 202m. There will be 2 full-mechanized production panels whose lengths will vary between 625m to 926m (Table 12).

The distance between EC100 and EC-200 varies between 0,40m to 20m.

Table 12. Panels of East EC100

PRODUCTION PANELS	COAL THICKNESS (M)	INTERBURDEN THICKNESS (M)	ROOF/FLOOR ROCK TO BE CUT (M)	CUTTING THICKNESS (M)	PANEL LENGTH (M)	FACE LENGTH (M)	R.O.M. DENSITY (TON/M ³)	R.O.M. RESERVE (TON)
EC100-101	1,25	-	-	1,25	625	202	1,63	257.234
EC100-102	1,62	0,84	0,02	2,49	926	202	1,77	605.745
TOTAL								862.980

Coal Density: 1,63 ton/m³, Interburden: 2,10 ton/m³, Sandstone: 2,60 ton/m³

SEAM EC-200

Seam thickness varies between 1,85m and 2,02m. There is an interburden in the seam and its thickness varies between 0,20m and 0,49m. Face will be operated between 6° and 12°. Operational height of the face will be from 1,10m to 2,30m due seam thickness and the selected shearer machine. Face width will be 202m. There will be 2 full-mechanized production panels whose lengths will vary between 625m to 926m (Table 13).

The distance between EC-200 and EC300 varies between 6m to 20m.

Table 13. Panels of East EC-200

PRODUCTION PANELS	COAL THICKNESS (M)	INTERBURDEN THICKNESS (M)	ROOF/FLOOR ROCK TO BE CUT (M)	CUTTING THICKNESS (M)	PANEL LENGTH (M)	FACE LENGTH (M)	R.O.M. DENSITY (TON/M ³)	R.O.M. RESERVE (TON)
EC200-103	1,65	0,20	-	1,85	625	202	1,68	392.574
EC200-104	1,61	0,54	-	2,14	926	202	1,74	589.571
TOTAL								982.145

Coal Density: 1,63 ton/m³, Interburden: 2,10 ton/m³, Sandstone: 2,60 ton/m³

SEAM EC300

Seam thickness varies between 1,45m and 3,95m. There is an interburden in the seam and its thickness varies between 0,10m and 0,95m. Face will be operated between 6° and 12°. Operational height of the face will be from 2,00m to 4,00m due seam thickness and the selected shearer machine. Face width will be 202m-204m (only one face has 153m width). There will be 7 full-mechanized production panels whose lengths will vary between 625m to 1989m (Table 14).

The distance between EC300 and EC400 varies between 10m to 44m.

Table 14. Panels of East EC300

PRODUCTION PANELS	COAL THICKNESS (M)	INTERBURDEN THICKNESS (M)	ROOF/FLOOR ROCK TO BE CUT (M)	CUTTING THICKNESS (M)	PANEL LENGTH (M)	FACE LENGTH (M)	R.O.M. DENSITY (TON/M ³)	R.O.M. RESERVE (TON)
EC300-105	2,10	0,55	-	2,65	625	202	1,73	577.973
EC300-106	2,74	0,90	-	3,64	926	202	1,75	1.089.414
EC300-107	2,28	0,77	0,04	3,08	1.410	204	1,80	1.581.015
EC300-108	1,98	0,32	0,01	2,31	1.410	204	1,72	1.010.129
EC300-109	2,11	0,86	0,03	2,99	882	204	1,79	806.953
EC300-110	2,04	0,46	0,17	2,67	1.989	204	1,79	1.921.759
EC300-111	2,04	0,42	-	2,46	1.989	204	1,71	1.704.472
EC300-112	2,06	0,47	0,26	2,79	1.861	204	1,96	2.009.981
EC300-113	1,58	0,48	0,48	2,54	1.097	204	1,98	1.095.020
TOTAL								11.796.715

Coal Density: 1,63 ton/m³, Interburden: 2,10 ton/m³, Sandstone: 2,60 ton/m³

SEAM EC400

Seam thickness varies between 1,50m and 3,80m. There is an interburden in the seam and its thickness varies between 0,05m and 0,40m. Face will be operated between 6° and 12°. Operational height of the face will be from 2,00m to 4,00m due seam thickness and the selected shearer machine. Face width will be 202m-204m except one panel having 153m face width. There will be 8 full-mechanized production panels whose lengths will vary between 625m to 2026m (Table 15).

The distance between EC400 and EC500 varies between 0,40m to 19m. Although these two seams are getting close to each other at the northern parts, they will be produced separately. When developing the gateways of EC400 hanging wall will be cut rather than its footwall and vice-versa for EC500 in order not to disturb the pillar distance between the two seams.

Table 15. Panels of East EC400

PRODUCTION PANELS	COAL THICKNESS (M)	INTERBURDEN THICKNESS (M)	ROOF/FLOOR ROCK TO BE CUT (M)	CUTTING THICKNESS (M)	PANEL LENGTH (M)	FACE LENGTH (M)	R.O.M. DENSITY (TON/M ³)	R.O.M. RESERVE (TON)
EC400-114	1,80	-	0,20	2,00	625	202	1,92	484.519
EC400-115	3,29	0,65	-	3,95	926	202	1,71	1.216.720
EC400-116	2,93	0,05	-	2,98	1.410	204	1,64	1.401.851
EC400-117	3,19	0,11	-	3,30	1.410	204	1,65	1.561.723
EC400-118	2,36	-	-	2,36	1.410	204	1,63	1.105.504
EC400-119	2,42	0,15	-	2,57	882	204	1,65	765.642
EC400-120	2,06	0,07	0,26	2,39	2.026	204	1,77	1.731.446
EC400-121	2,20	0,23	-	2,44	2.026	204	1,67	1.668.125
EC400-122	2,25	0,32	0,09	2,65	1.889	204	1,84	1.834.232
EC400-123	2,53	0,22	0,01	2,77	1.125	204	1,68	1.062.858
TOTAL								12.832.621

Coal Density: 1,63 ton/m³, Interburden: 2,10 ton/m³, Sandstone: 2,60 ton/m³

SEAM EC500

Seam thickness varies between 0,75m and 4,25m. There is an interburden in the seam and its thickness varies between 0,08m and 0,40m. Face will be operated between 6° and 12°. Operational height of the face will be from 2,00m to 4,00m due seam thickness and the selected shearer machine. Face width will be 202m-204m except two panels having 153m and 194 face width. There will be 11 full-mechanized production panels whose lengths will vary between 625m to 2026m (Table 16).

Since the EC400 and EC500 will be produced separately, the gateways of these two seams will not be in line in the vertical plane and the footwall will be cut during gateway development of EC500 to avoid a connection with the gob areas of the upper seam. It means the shearer will cut footwall rock for a 10m long part at the beginning per panel during production.

The production in EC500 will be commenced after five years from the end of production of EC400 panels.

Table 16. Panels of East EC500

PRODUCTION PANELS	COAL THICKNESS (M)	INTERBURDEN THICKNESS (M)	ROOF/FLOOR ROCK TO BE CUT (M)	CUTTING THICKNESS (M)	PANEL LENGTH (M)	FACE LENGTH (M)	R.O.M. DENSITY (TON/M ³)	R.O.M. RESERVE (TON)
EC500-124	2,80	-	-	2,80	625	202	1,63	576.205
EC500-125	2,95	0,05	-	3,00	926	202	1,64	919.693
EC500-126	2,86	0,08	0,21	3,15	1.410	204	1,74	1.493.939
EC500-127	3,72	0,21	-	3,94	1.410	204	1,66	1.780.367
EC500-128	2,40	-	-	2,40	1.410	204	1,63	1.125.717
EC500-129	2,38	0,10	0,02	2,50	882	204	1,68	754.007
EC500-130	2,05	-	0,21	2,26	2.026	204	1,73	1.605.074
EC500-131	2,09	0,25	0,08	2,42	2.026	204	1,72	1.713.784
EC500-132	2,29	0,28	-	2,56	1.889	204	1,68	1.659.385
EC500-133	1,63	0,11	0,51	2,24	1.125	204	1,90	586.068
TOTAL								12.214.238

Coal Density: 1,63 ton/m³, Interburden: 2,10 ton/m³, Sandstone: 2,60 ton/m³

SEAM EC600

Seam thickness varies between 0,50m and 2,15m. There is an interburden in the seam and its thickness varies between 0,15m and 0,50m. Face will be operated between 6° and 12°. Operational height of the face will be from 1,10m to 2,30m due seam thickness and the selected shearer machine. Face width will be 202-204m except one panel having 174m face width. There will be 7 full-mechanized production panels whose lengths will vary between 625m to 2026m (Table 17).

The distance between EC500 and EC600 varies between 2m to 15m.

Table 17. Panels of East EC600

PRODUCTION PANELS	COAL THICKNESS (M)	INTERBURDEN THICKNESS (M)	ROOF/FLOOR ROCK TO BE CUT (M)	CUTTING THICKNESS (M)	PANEL LENGTH (M)	FACE LENGTH (M)	R.O.M. DENSITY (TON/M ³)	R.O.M. RESERVE (TON)
EC600-134	1,05	0,45	-	1,50	625	202	1,77	335.383
EC600-135	0,89	0,58	-	1,48	926	202	1,82	501.233
EC600-136	1,17	0,16	0,13	1,46	1.410	204	1,80	744.028
EC600-137	1,08	0,17	0,18	1,43	1.410	204	1,85	744.588
EC600-138	0,97	-	0,13	1,10	1.410	204	1,75	552.730
EC600-139	1,08	0,05	0,15	1,27	882	204	1,78	402.453
EC600-140	1,07	0,29	0,05	1,41	2.026	204	1,77	1.028.783
EC600-141	0,86	0,07	0,17	1,10	2.026	204	1,81	822.642
EC600-142	0,96	0,22	0,34	1,52	1.125	204	1,99	669.789
TOTAL								5.801.630

Coal Density: 1,63 ton/m³, Interburden: 2,10 ton/m³, Sandstone: 2,60 ton/m³

After a panel is finished, equipments will be overhauled in order to work properly and then transported to the new panel and installed. It is planned to perform these works within 45 days. Production target in these panels is 6000ton/day if shearer loader or 3000ton/day if plow is used.

130 personnel will be employed for the full-mechanized production panels of the EC300. Advance rate will be 9,73m/day and 292m/month and face efficiency will be 46,2ton/man-wage. In the calculations, minimum cutting height is assumed to be 2,00m and density is assumed to be 1,68ton/m³.

130 personnel will be employed for the full-mechanized production panels of the EC400. Advance rate will be 9,73m/day and 292m/month and face efficiency will be 46,2ton/man-wage. In the calculations, minimum cutting height is assumed to be 2,00m and density is assumed to be 1,68ton/m³.

130 personnel will be employed for the full-mechanized production panels of the EC500. Advance rate will be 9,73m/day and 292m/month and face efficiency will be 46,2ton/man-wage. In the calculations, minimum cutting height is assumed to be 2,00m and density is assumed to be 1,68ton/m³.

130 personnel will be employed for the full-mechanized production panels of the EC600. Advance rate will be 7,95m/day and 239m/month and face efficiency will be 26,9ton/man-wage. In the calculations, minimum cutting height is assumed to be 1,10m and density is assumed to be 1,68ton/m³.

3.1.1.1. MINING METHOD TO BE APPLIED IN EAST PRODUCTION BLOCK

In East Block, production panels are named as EC100-101, EC100-102 and so on from north to south. Longwall faces will be operated as single cut, retreat and back-caving. Face width will be 204m and panel length will be 650-2200m.

The tailgate is also allowed to cave, but maingate is supported with pack walls and maintained for the next panel. Width of pack walls will be 4-8m and height will be the same with the excavated height. The maingate of a former panel will be used as the tailgate of the latter panel (Figure 19, Figure 20, Figure 21).

The main reason why the back-caving U-type longwall has been chosen for the production method is that, Westphalia-C coal in the production Block has high spontaneous combustion risk.

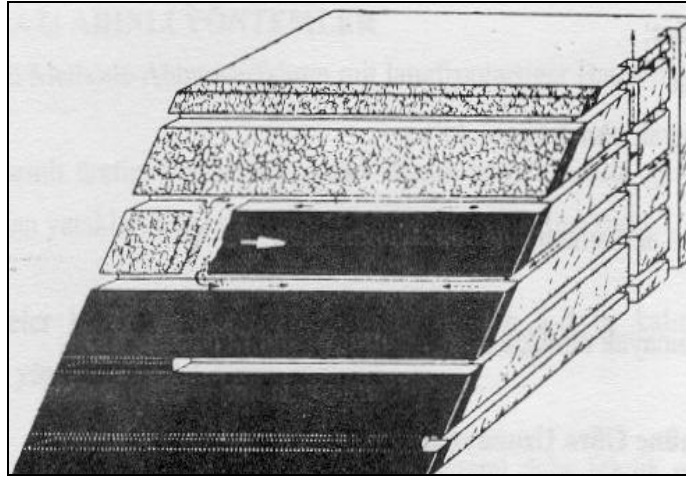

Figure 19. Generalized Sequence of Longwall Mining Method

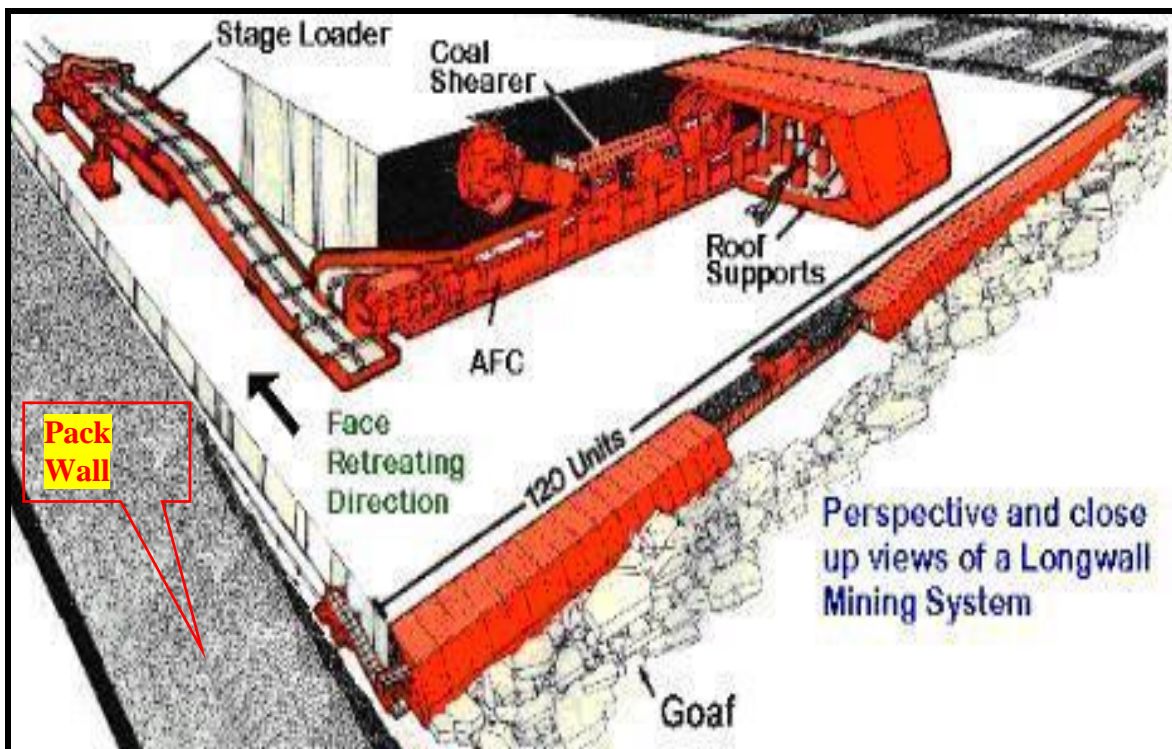

Figure 20. Coal Production in Full-Mechanized Longwall Method

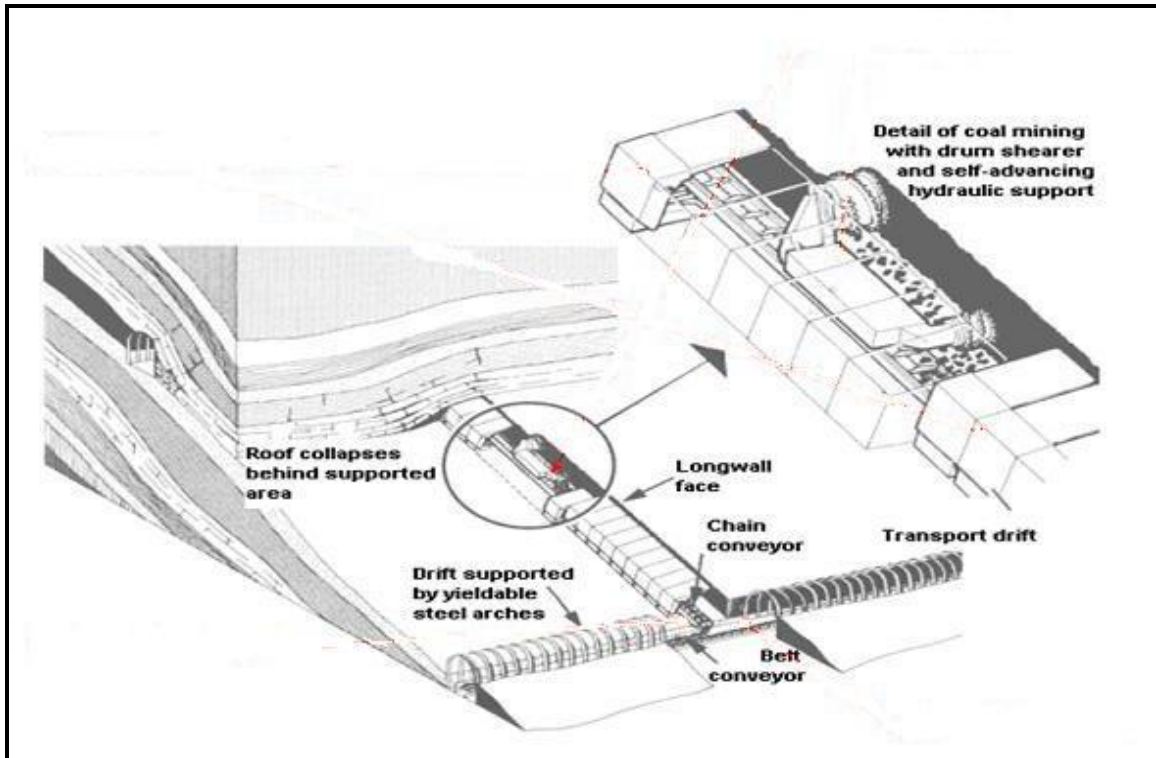

Figure 21. Coal Production Sequence In Full-Mechanized Longwall Method

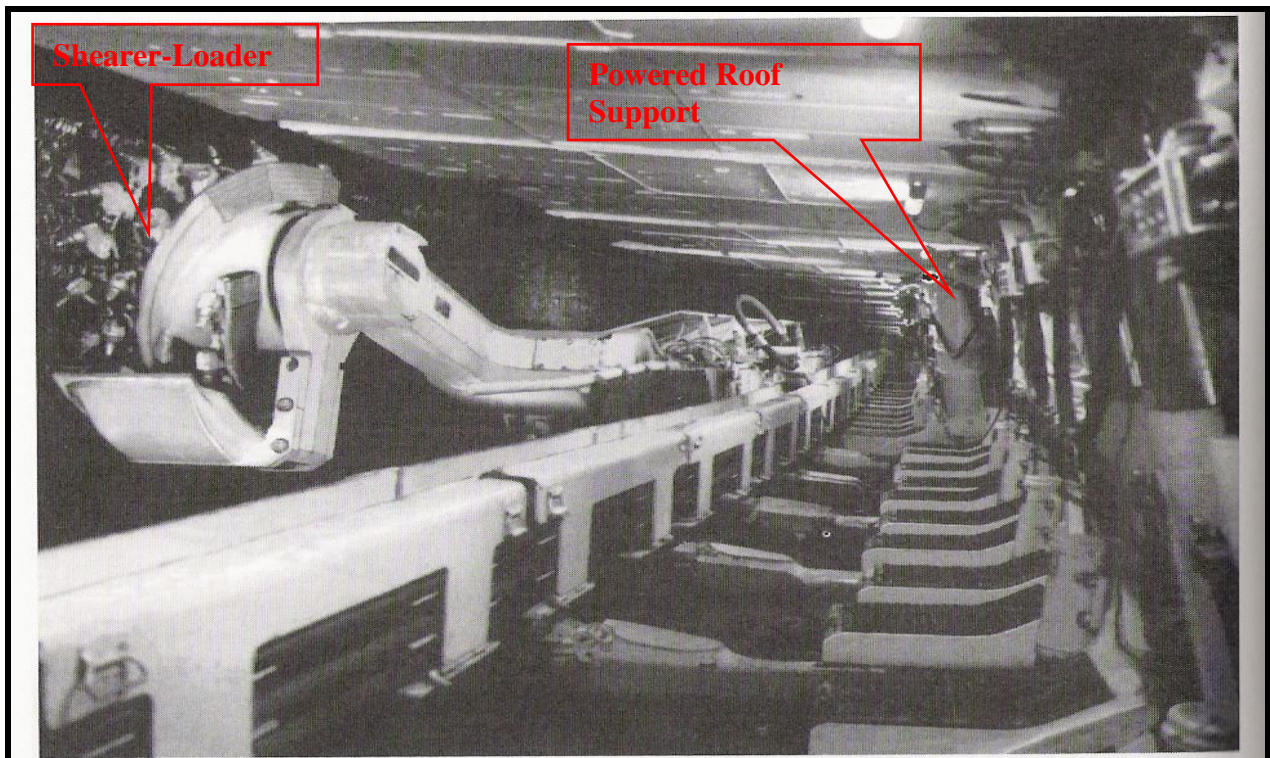

Figure 22. Shearer-Loader and Powered Roof Supports

Face will be supported with minimum 1800mm high power supports (Figure 22). Double drum shearer will cut coal seams having 4,0m (max.) thickness and ave. 1,68 ton/m³ density. Cutting capacity will be at least 1900ton/hour.

Coal will be loaded to AFC and conveyed to stage loader. Particle size will be reduced to desired size with the crusher mounted on the stage loader. From stage loader coal will be loaded to belt conveyor and transported to the shaft bottoms.

3.1.1.2. ROCK MECHANICS AND CUTTABILITY STUDIES FOR EQUIPMENT SELECTION

In order to make a proper mechanized equipment selection, several rock mechanics tests and cutting studies were carried out by Istanbul Technical University accredited laboratories and by Sandvik. Summarized results are given in Table 18, Table 19, Table 20 and Table 21. Tests are applied to both core and block samples taken from HEMA boreholes and TTK adjacent production panel developments and production panel. Results of cutting tests completed by Istanbul Technical University are also given as Appendix-46. Rock mechanics tests done by Zonguldak Karaelmas University (ZKU) and Sandvik are also given as Appendix-47 and Appendix-48, respectively. Geotechnical report of Pilot-1 borehole is also given as Appendix-49.

Table 18. Small Scale Cutting Test Results

	Density (g/cm ³)	Depth of Cut (mm)	Specific Energy (MJ/m ³)	Ave. Specific Energy (MJ/m ³)	Ave. Specific Energy (kWh/m ³)
3. Seam Roof Rock (Sandstone)	2,48	4,05	19,85	16,19	4,50
		4,25	13,86		
		4,30	26,35		
		5	24,74	20,65	5,74
		5	25,22		
		5	14,31		
		5	18,32		
3. Seam	1,20	3	9,72	7,49	2,08
		3	7,91		
		5	7,99	6,34	1,76
		5	7,80		
		5	3,23		
		7	3,03	2,53	0,70
		7	3,73		
3. Seam Floor Rock (Siltstone)	2,60	3	28,28	22,20	6,17
		3	12,39		
		5	35,43		
		5	14,25	16,96	4,71
		5	16,58		
		5	18,02		
		5	16,97		
		5	18,99		

Table 19. Block Sample UCS Test Results

	Density (g/cm ³)	UCS (MPa)	Failure Load (kN)
3. Seam Roof Rock (Sandstone)	2,47	23,2	50,7
	2,49	37,7	82,5
	2,48	48,7	112,1
	2,47	37,3	86,0
3. Seam Floor Rock (Siltstone)	2,56	31,2	70,8
	2,55	88,1	199,0
	2,52	27,5	63,6
	2,79	22,5	52,1
3. Seam	-	49-53	-

Table 20. Core Sample UCS Test Results (by Sandvik)

	Density (g/cm ³)	UCS (MPa)
Sandstone (-420)	2,61	54,20
Sandstone (-411)	2,63	73,22
Siltstone (-501)	2,70	89,74
Sandstone (-527)	2,58	59,00
Conglomerate Sandstone (-545)	2,63	98,91
Siltstone (-555)	2,62	110,89
Sandstone (-562)	2,60	76,78
Siltstone (-569)	2,62	74,09
Sandstone (-452)	2,60	79,18
Sandstone (-439)	2,51	31,27
Sandstone (-469)	2,67	156,08
Conglomerate (-481)	2,60	111,94
3. Seam	-	47
4. Seam	-	43
5. Seam	-	14,1

Table 21. Point Load Test Results

	Failure Pressure (bar)	Failure Load (N)	Point Load Index (MPa)	Corrected Point Load Index (MPa)	Converted Compressive Strength (MPa)
3. Seam	5	721	0,22	0,22	5,3
3. Seam	5	721	0,17	0,20	4,8
3. Seam	5	721	0,18	0,22	5,2
3. Seam	5	721	0,16	0,18	4,3
3. Seam	5	721	0,14	0,17	4,0

3.1.1.3. FACE EQUIPMENT TO BE USED IN EAST PRODUCTION BLOCK

In East Block, the representative cross sectional views of a powered roof support to be used in longwall panels of No.3, EC400 and EC500 are shown on the below figures (Figure 23, Figure 24, Figure 25).



Figure 23. Model view of powered roof support

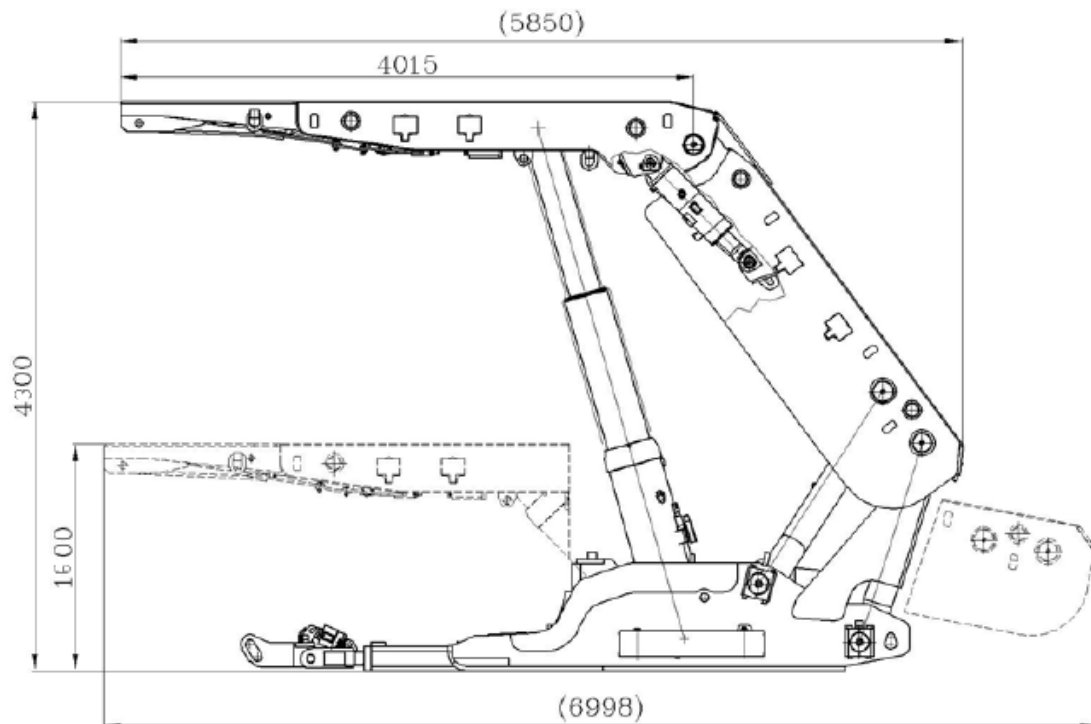

Figure 24. Cross section of powered roof support

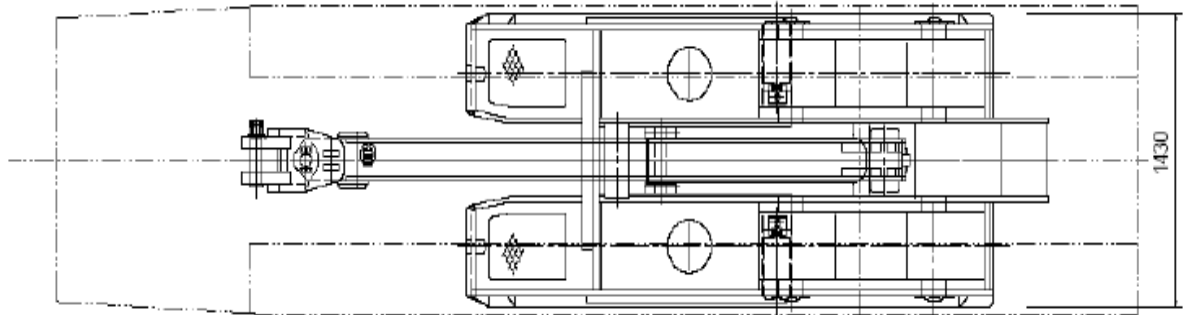

Figure 25. Plan view of powered roof support

In the production face, 160-167 pcs of basic line powered roof supports will be used. Operating range of these two-leg type powered roof supports is 2,00m-4,00m. An individual support will have 1,50m center to center width and it weights will be app. 25ton. Yield load and support resistance of roof supports will be according to calculations in Article 2.6. Special type of transition shield and gate road shield in tailgate and transition between gateway and face may be used.

Control system of powered roof supports will be 12-14-functioned, pilot controlled.

In East Block, shearer loader machine will be used for thick seams. Estimated specifications of shearer will be as follows: Each cutter drum is driven by 300-480 kW-electrical motor. Dimensions of each drum are 2000 x 850/900mm, and 39 rpm is the rotational speed. Total installed power is 780-1140 kW. Operating voltage of the cutter-drum is 3300V. Machine itself has a length of 7,9m and its weight is app. 50 ton. Maximum cutting height is 4,00m and walking speed is 34 m/min (Figure 26).

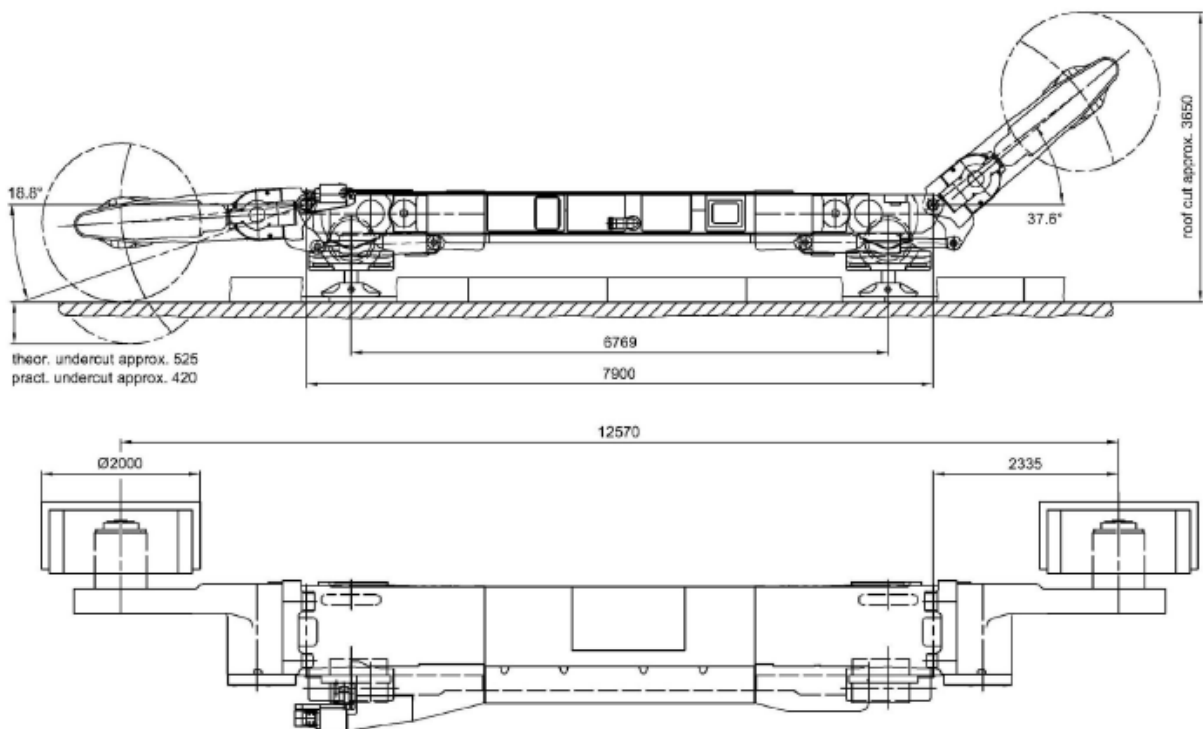

Figure 26. Shearer Loader

Estimated specifications of beam stage loader and AFC will be as follows: Stage loader will have double-chain and power of its drive units will be app. 400kW (Figure 27). Capacity of

the stage loader will be 2000ton/h. Capacity of the AFC will be 1800ton/h and it will be driven by app. 2x400 kW power. In both stage loader and AFC 2x34x126mm chain will be used.

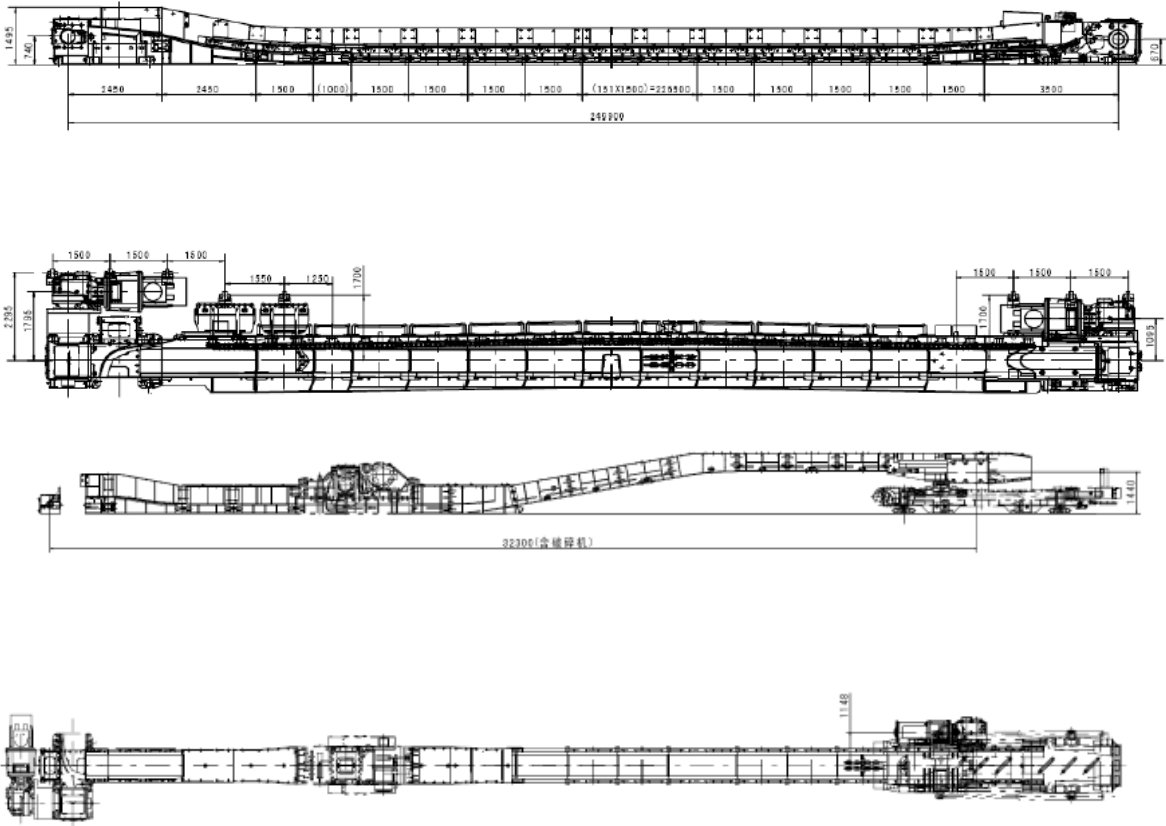

Figure 27. AFC and Stage Loader

On both conveyors, tension units will be mounted. Transfer of coal from AFC to stage will be performed by side-dump-chute. 200 kW-power and 2000ton/h-capacity crusher will be mounted on the stage-loader (Figure 28).

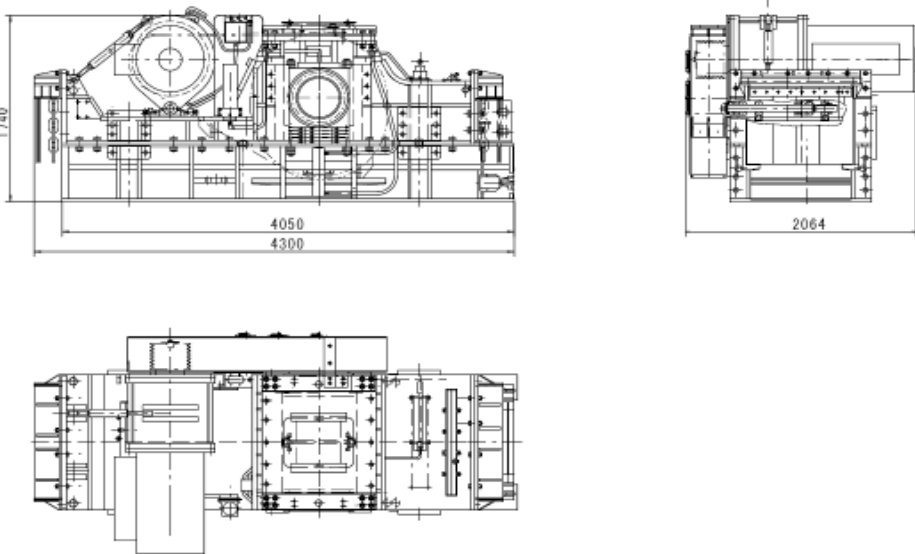

Figure 28. Crusher

3.1.1.4. PACK WALL SYSTEM TO BE APPLIED IN MAINGATES OF EAST PRODUCTION BLOCK

As for the mining method to be applied, maingates will be used for a second time in the adjacent panels of same seam as tailgate. In order to make maingates remain steady for sufficient time, pack wall system will be applied for the whole length of “coal-produced-panel-side” of the maingate. The reason pillar system hasn't been chosen instead of pack wall system is that disturbed pillars under stresses will lead to reserve loss and spontaneous combustion.

Moreover, in order to prevent stress disturbance of upper level seam gateways to the below level seam gateways, gateway axis will be out of effect area of upper gateways.

After supported and maintained, maingate of a panel will serve as the tailgate of next panel. It will be supported with pack walls in order to reduce the deformations to the gateway supports caused by the stresses. Recommendation from the similar operations, the width of pack walls will around 4m and height will be the same with the excavated height.

In East Block, four silo having 100ton capacity will be constructed on Shaft No.1 surface layout for packing system. Two of them will be used for cement and ash storage and the remaining two will be used for mixture storage. Mixture will be prepared from electro-filtered ash and cement (30%). Ash will be obtained from thermal power plant to be founded. Since then, the raw material for packing system will be supplied from storage silos. General flow chart of pack wall system is given in Figure 29. Technical details of surface layout of pack wall system (silos etc.) is available on site if required and some are attached as Appendix-19.

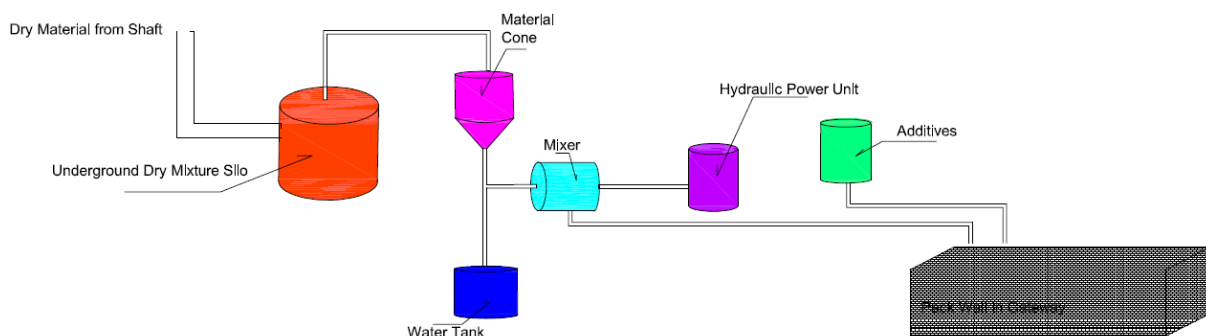

Figure 29. Pack Wall System

The dry mixture from the silos will be send to -410 underground subsilo through pipes with compressed air. Aggregate will be sent to smaller subsilos located in the gateway. Water will be added to the dry mixture in this subsilo. Water added mixture will be pumped by concrete pump from the subsilo to the location where packing will be applied. Neutral sodium-silicate at 1,5-2% will be used as setting accelerator.

3.1.2. WEST BLOCK COAL SEAMS AND PRODUCTION PLANNING

Production project covers an area of 3,7km² in West Block. Area of our interest in West Block is the part surrounded by the Central Fault at the east, Fault No.3 at the North (Figure 30).

In West Block some of the coals of Karadon series have been washed out in the zone raised under the influence of the Central Fault and some of the coals of Karadon series have been

slipped to east under the influence of gravity. In Kozlu formation, project has been prepared for 7 coal seams having recoverable thickness and sufficient borehole data and these seams are said to be Westphalia-A aged. These seams exist between -250 and -800 levels and are given the names WA100, WA200, WA300, WA400, WA500, WA600 and WA700 from top to the bottom, respectively. In this area, seams having minimum 0,95m thickness have been assumed to be the recoverable. Correlation studies of Westphalia-A aged seams below -540 in Northwest and below -800 in Southwest are still on progress.

In this area there is Fault No.3 restricting the length of panels (Figure 30). Full-mechanized panels, primarily planned to be produced, are oriented according to the existing faults and the reserve of those panels is app. 36,8 million ton. Reserve of panels where inadequate data and unrecoverable seam thickness occurs is not included to reserve calculations. Seam inclinations vary between 15° and 17°. Production figures of West Block are given in Graph 1 and Graph 3.

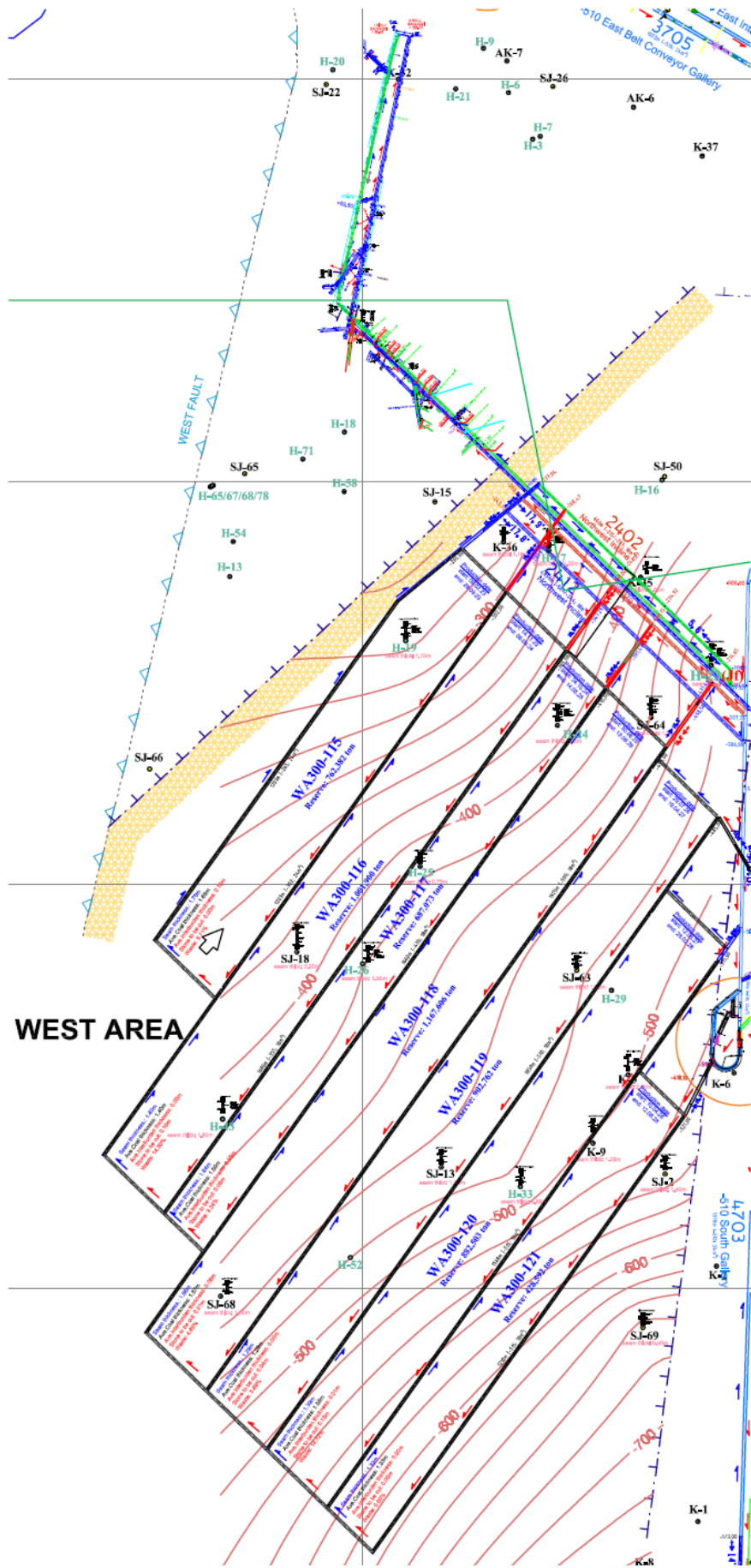

Figure 30. West Production Block

3.1.2.1. SHALLOW COALS (WEST BLOCK)

Amasra Hardcoal Project has been planned for -400/-530 levels at East Block, -250/-600 at West Block and -600/-900 levels at Southeast Block. In addition to this, license field covers coals at +90/-20 levels in west area of Field and a Project, called Shallow Coal Project, has been planned for these coal seams. In this portion of the field production projects have been prepared for Westphalia-A aged two seams called WSA100 and WSA200 together with Westphalia-C aged four seams called WSC300, WSC400, WSC500 and WSC600. Shallow Coal Project is going to assist Amasra Hardcoal Project by Westphalian-A and Westphalian-C coal seam productions. Since the designed panel lengths and face lengths of these seams are insufficient for full-mechanized systems, semi-mechanized production methods will be employed. Drilling and blasting method will be used to excavate seams having various thicknesses. Seam thicknesses are varying between 0.80m and 4.30m. Coal will be produced from faces having 77-80m length, cutting depth will be 0.80m and 1,20-2.40m advance is planned per day, so it is planned to produce 227-800ton/day rom coal. Mine development plans specific to semi mechanized production areas are given as Appendices-52/55.

Shallow Coal Project covers a production reserve of approximately 5 Mt of coal. Coal will be produced by conventional and semi-mechanized systems and coal will be supplied for requirements, demands of small industrial plants and domestic heating purposes.

Detailed development timeline specific to Shallow Coals are given as Appendix-56. Investments and operational costs have been given in Appendix-36.A. and Appendix-36.B.

Surface layout of Shallow Coals is also given in Appendix-42.

Production method of Shallow Coals will be similar to Kandilli Operations.

3.1.2.1.1. Proposed Production Method for Shallow Coals

Semi-mechanized retreat longwall with steel support system will be used in West Shallow Block. Sequence of production is planned as follows shown in Figure 31.

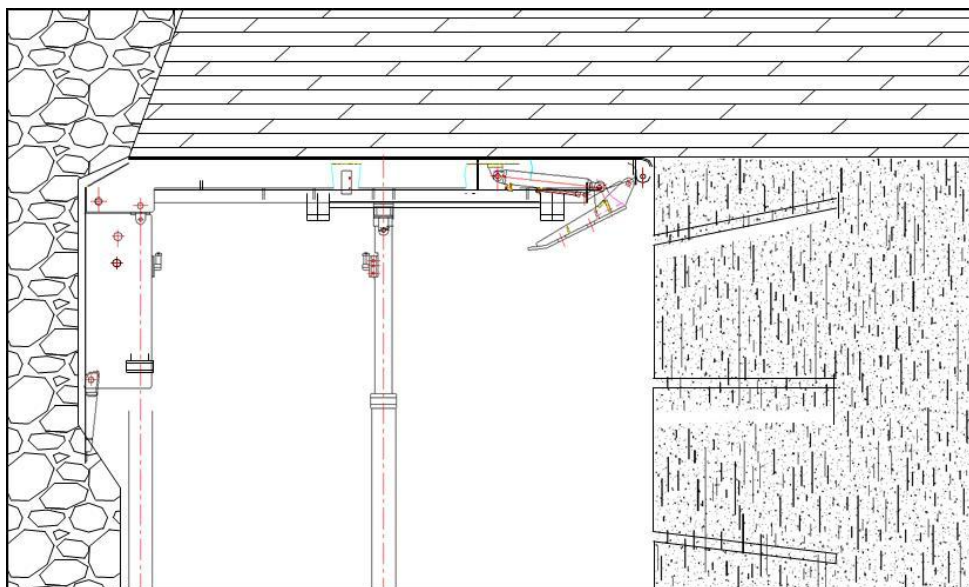

Figure 31. Drilling of blast holes into cutting face

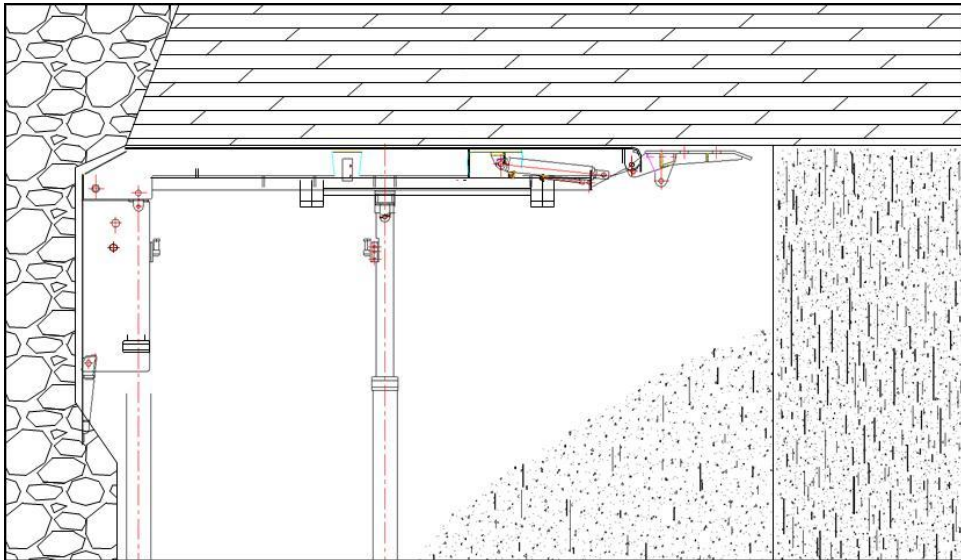

Figure 32. Opening of the front-shield to secure roof after blasting

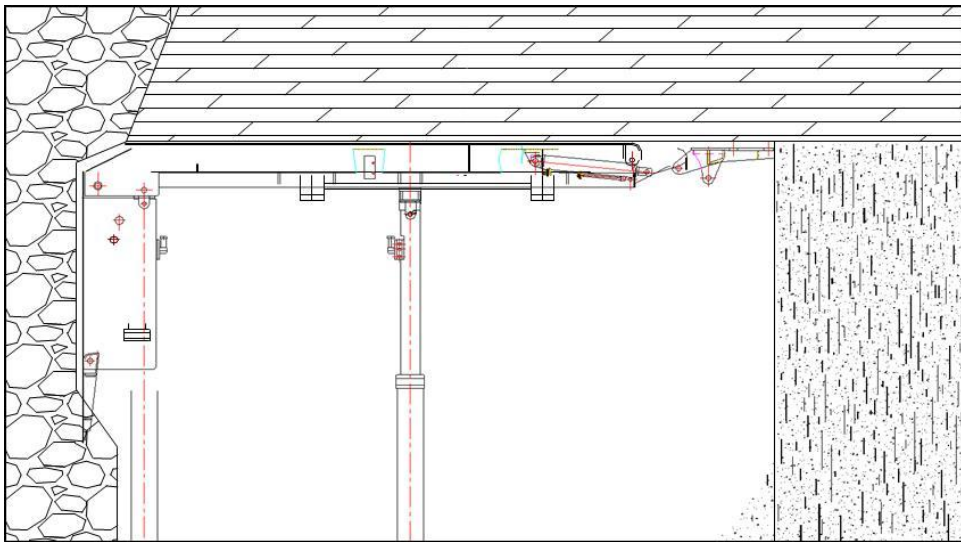

Figure 33. Taking the coal from gob site

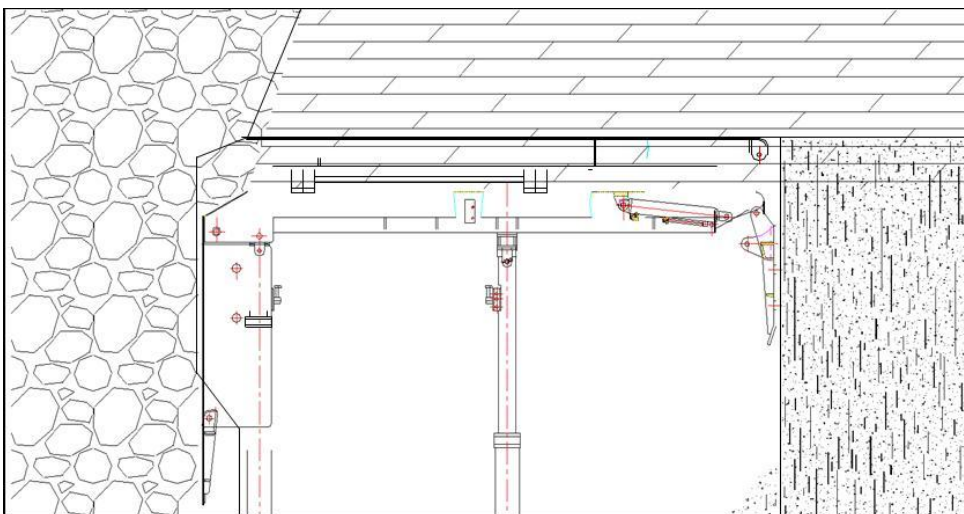

Figure 34. Offsetting the support after closing hinged shield

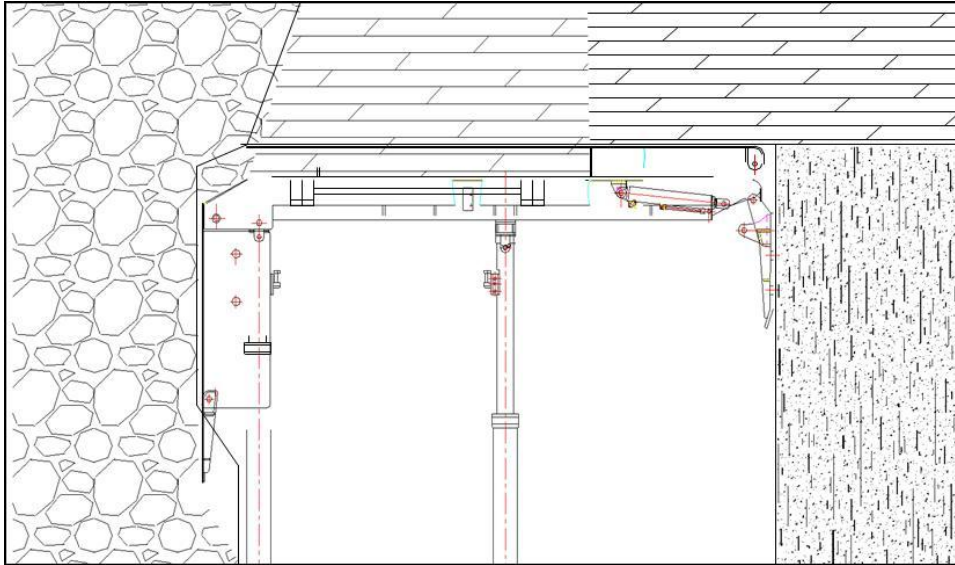

Figure 35. Taking cutting-face coal and dinting of the floor

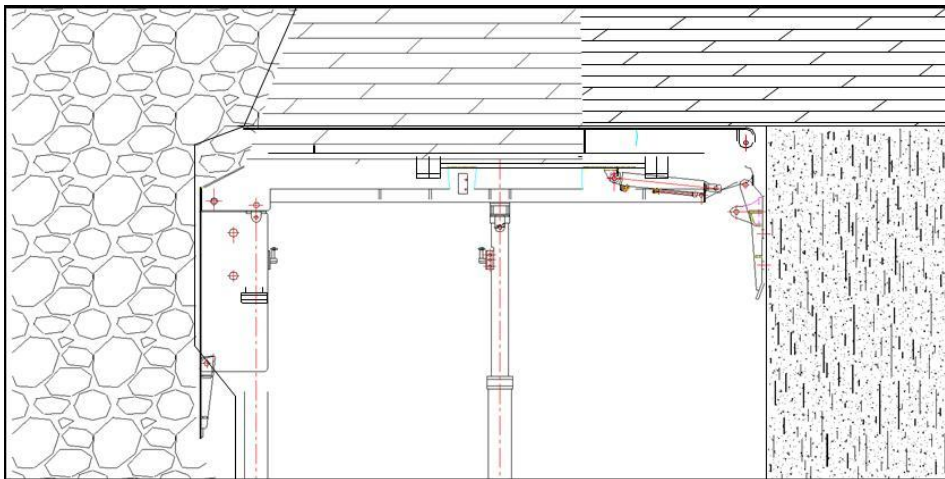

Figure 36. Offsetting of the conveyor

In high seams, the coal portions located above proposed hydraulic support type's operational range will be taken from behind the face (gobside). By caving of the roof during demounting phase the coal on the roof comes down. Coal coming with the fallen material will be drawn with a special shovel-like tool from the gobside and transferred to the face conveyor.

One of the issues needs to be paid attention during drawing of the coal from gobside is to ensure the roof has caved completely and immobilized. In case the roof does not cave itself it will be drilled and blasted to provide artificial caving. Another important issue is to avoid taking roof rock together with coal drawn since the roof rock will unnecessarily increase the waste ratio if mixed into the coal. The last important issue deserves to be mentioned here is to take coal from gobside as much as possible otherwise the spontaneous combustion risk will increase with the quantity of coal left behind (Figure 33).

3.1.2.1.2. Shallow Block Coal Seams And Production Panels

In the projected area, 3,271,875 ton coal reserve is determined as recoverable with semi-mechanized methods. Some possible panel locations where the existing data and/or correlated

seam thicknesses are insufficient have been excluded from the reserve estimation and they will be reassessed during underground development activities. (Appendix-56) Seam dips are varying from 4° to 21°. The production scenes of each seam are briefly explained below.

SEAM WSC300

Thickness of Seam WSC300 varies between min.1.27m and max.3.75m. This seam has Şiferton (fireclay) bands having thickness also varying between 0.28m and 0.55m. The interval between WSC300 and the below one (WSC400) varies from 14m to 23m.

To start semi-mechanized production from Seam WSC300; totally 446m-long horizontal or inclined cross-cut galleries in stone and 3711m-long horizontal or inclined gateways, rise-headings and facelines in coal have been planned to be developed.

For this seam five production panels having 386m to 542m lengths have been projected. Face lengths will be 77m according to proposed project. Face inclinations will vary between 4° and 6°. Operational height of the faces will be 1.10-1.80m according to the selected support (Type-I) and, where the seam thickness exceeds 1.80m coal remaining on the roof will be taken from behind the face (gobsite) as shown in (Figure 33). Specifications of the production panels are summarized in Table 22.

Table 22. Production Panels of WSC300

PRODUCTION PANELS	COAL THICKNESS (M)	INTERBURDEN THICKNESS (M)	CUTTING THICKNESS (M)	PANEL LENGTH (M)	FACE LENGTH (M)	R.O.M. DENSITY (TON/M ³)	R.O.M. RESERVE (TON)
WSC300-101	2.41	0.44	2.86	386	77	2.37	145,619
WSC300-102	2.06	0.55	2.61	386	77	1.74	134,855
WSC300-103	3.25	0.50	3.75	386	77	1.69	189,799
WSC300-104	0.99	0.28	1.27	477	77	1.73	39,208
WSC300-105	0.99	0.28	1.27	542	77	1.73	63,504
TOTAL							427,366

Densities are assumed as 1.63 and 2.10t/m³ for coal and interburden (seam dirt) respectively.

Seam WSC300's total recoverable reserve is estimated to be 516,090ton together with the coal excavated during gateway developments. Gateways will have 14m² net sectional area.

SEAM WSC400

Thickness of Seam WSC400 varies between min.1.14m and max.1.75m. Interburden (seam dirt) thickness also varies between 0.03m and 0.04m. The interval between WSC400 and the below one (WSC500) varies from 15m to 20m.

To start semi-mechanized production from Seam WSC400; totally 400m-long horizontal or inclined cross-cut galleries in stone and 3291m-long horizontal or inclined gateways, rise-headings and facelines in coal have been planned to be developed.

For this seam four production panels having 386m to 613m lengths have been projected. Face lengths will be 77m according to proposed project. Face inclinations will vary between 3° and 8°. Operational height of the faces will be 1.10-1.80m according to the selected support (Type-I) and, where the seam thickness exceeds 1.80m coal remaining on the roof will be taken from behind the face (gobsite) as shown in Figure 33. Specifications of the production panels are summarized in Table 23.

Table 23. Production Panels of WSC400

PRODUCTION PANELS	COAL THICKNESS (M)	INTERBURDEN THICKNESS (M)	CUTTING THICKNESS (M)	PANEL LENGTH (M)	FACE LENGTH (M)	R.O.M. DENSITY (TON/M ³)	R.O.M. RESERVE (TON)
WSC400-106	1.75	-	1.75	386	77	1.63	83,078
WSC400-107	1.11	0.03	1.14	477	77	1.64	33,422
WSC400-108	1.11	0.04	1.14	542	77	1.64	51,042
WSC400-109	1.11	0.04	1.14	613	77	1.64	57,905
TOTAL							225,447

Densities are assumed as 1.63 and 2.10t/m³ for coal and interburden (seam dirt) respectively.

Seam WSC400's total recoverable reserve is estimated to be 314,171ton together with the coal excavated during gateway developments. Gateways will have 14m² net sectional area.

SEAM WSC500

Thickness of Seam WSC500 varies between min.1.09m and max.2.00m. Interburden (seam dirt) thickness is 0.10m. The interval between WSC500 and the below one (WSC600) varies from 4m to 20m.

To start semi-mechanized production from Seam WSC500; totally 191m-long horizontal or inclined cross-cut galleries in stone and 4437m-long horizontal or inclined gateways, rise-headings and facelines in coal have been planned to be developed.

For this seam six production panels having 386m to 613m lengths have been projected. Face lengths will be 77m according to proposed project. Face inclinations will vary between 11° and 12°. Operational height of the faces will be 1.10-1.80m according to the selected support (Type-I) and, where the seam thickness exceeds 1.80m coal remaining on the roof will be taken from behind the face (gobsite) as shown in Figure 33. Specifications of the production panels are summarized in Table 24.

Table 24. Production Panels of WSC500

PRODUCTION PANELS	COAL THICKNESS (M)	INTERBURDEN THICKNESS (M)	CUTTING THICKNESS (M)	PANEL LENGTH (M)	FACE LENGTH (M)	R.O.M. DENSITY (TON/M ³)	R.O.M. RESERVE (TON)
WSC500-110	1.42	0.04	1.46	386	77	1.64	71,704
WSC500-111	2.00	-	2.00	386	77	1.63	97,479
WSC500-112	2.00	-	2.00	386	77	1.63	97,479
WSC500-113	0.98	0.10	1.09	477	77	1.67	32,382
WSC500-114	0.99	0.10	1.09	542	77	1.67	49,365
WSC500-115	0.99	0.10	1.09	613	77	1.67	55,927
TOTAL							404,335

Densities are assumed as 1.63 and 2.10t/m³ for coal and interburden (seam dirt) respectively.

Seam WSC500's total recoverable reserve is estimated to be 493,059ton together with the coal excavated during gateway developments. Gateways will have 14m² net sectional area.

SEAM WSC600

Thickness of Seam WSC600 varies between min.1.24m and max.1.32m. Interburden (seam dirt) thickness also varies between 0.26m and 0.47m.

To start semi-mechanized production from Seam WSC600; totally 286m-long horizontal or inclined cross-cut galleries in stone and 1468m-long horizontal or inclined gateways, rise-headings and facelines in coal have been planned to be developed.

For this seam two production panels having 386m length have been projected. Face lengths will be 77m according to proposed project. Face inclinations will be between 8°. Operational height of the faces will be 1.10-1.80m according to the selected support (Type-I) and, where the seam thickness exceeds 1.80m coal remaining on the roof will be taken from behind the face (gobsite) as shown in Figure 33. Specifications of the production panels are summarized in Table 25.

Table 25. Production Panels of WSC600

PRODUCTION PANELS	COAL THICKNESS (M)	INTERBURDEN THICKNESS (M)	CUTTING THICKNESS (M)	PANEL LENGTH (M)	FACE LENGTH (M)	R.O.M. DENSITY (TON/M ³)	R.O.M. RESERVE (TON)
WSC600-116	0.98	0.26	1.24	386	77	1.71	64,188
WSC600-117	0.85	0.47	1.32	386	77	1.77	70,656
TOTAL							134,844

Densities are assumed as 1.63 and 2.10t/m³ for coal and interburden (seam dirt) respectively.

Seam WSC600's total recoverable reserve is estimated to be 223,568ton together with the coal excavated during gateway developments. Gateways will have 14m² net sectional area.

SEAM WSA100

Thickness of Seam WSA100 varies between min.0.95m and max.4.30m. Interburden (seam dirt) thickness also varies between 0.19m and 0.40m. The interval between WSA100 and the below one (WSA200) varies from 46m to 65m.

To start semi-mechanized production from Seam WSA100; totally 1309m-long horizontal or inclined cross-cut galleries in stone and 7258m-long horizontal or inclined gateways, rise-headings and facelines in coal have been planned to be developed.

For this seam six production panels having 285m to 651m lengths have been projected. Face lengths will be 78-80m according to proposed project. Face inclinations will vary between 14° and 20°. Operational height of the faces will be 1.60-2.50m according to the selected support (Type-II) and, where the seam thickness exceeds 2.50m coal remaining on the roof will be taken from behind the face (gobsite) as shown in Figure 33. Specifications of the production panels are summarized in Table 26.

Table 26. Production Panels of WSA100

PRODUCTION PANELS	COAL THICKNESS (M)	INTERBURDEN THICKNESS (M)	CUTTING THICKNESS (M)	PANEL LENGTH (M)	FACE LENGTH (M)	R.O.M. DENSITY (TON/M ³)	R.O.M. RESERVE (TON)
WSA100-101	3.90	0.40	4.30	285	78	1.67	154,520
WSA100-102	3.35	0.19	3.55	321	78	1.65	143,065
WSA100-103	2.78	-	2.78	354	78	1.63	123,092
WSA100-104	0.95	0.15	1.10	484	80	1.69	70,193
WSA100-105	1.70	0.25	1.95	611	80	1.69	146,969
WSA100-106	1.39	0.20	1.59	651	80	1.38	154,454
TOTAL							792,295

Densities are assumed as 1.63 and 2.10t/m³ for coal and interburden (seam dirt) respectively.

Seam WSA100's total recoverable reserve is estimated to be 881,019ton together with the coal excavated during gateway developments. Gateways will have 14m² net sectional area.

SEAM WSA200

Thickness of Seam WSA200 varies between min.0.80m and max.2.31m. Interburden (seam dirt) thickness also varies between 0.15m and 0.37m.

To start semi-mechanized production from Seam WSA200; totally 308m-long horizontal or inclined cross-cut galleries in stone and 7516m-long horizontal or inclined gateways, rise-headings and facelines in coal have been planned to be developed.

For this seam six production panels having 285m to 651m lengths have been projected. Face lengths will be 78-80m according to proposed project. Face inclinations will vary between 11° and 12°. Operational height of the faces will be 1.60-2.50m according to the selected support (Type-II) and, where the seam thickness exceeds 2.50m coal remaining on the roof will be taken from behind the face (gobsite) as shown in Figure 33. Specifications of the production panels are summarized in Table 27.

Table 27. Production Panels of WSA200

PRODUCTION PANELS	COAL THICKNESS (M)	INTERBURDEN THICKNESS (M)	CUTTING THICKNESS (M)	PANEL LENGTH (M)	FACE LENGTH (M)	R.O.M. DENSITY (TON/M ³)	R.O.M. RESERVE (TON)
WSA200-107	0.80	-	0.80	285	78	1.63	27,997
WSA200-108	1.62	-	1.62	321	78	1.63	64,197
WSA200-109	2.31	0.37	2.68	354	78	1.69	123,134
WSA200-110	1.20	0.15	1.35	484	80	1.68	85,543
WSA200-111	1.50	0.30	1.80	611	80	1.71	137,115
WSA200-112	1.60	0.35	1.95	651	80	1.71	171,637
TOTAL							609,624

Densities are assumed as 1.63 and 2.10t/m³ for coal and interburden (seam dirt) respectively.

Seam WSA200's total recoverable reserve is estimated to be 698,349ton together with the coal excavated during gateway developments. Gateways will have 14m² net sectional area.

3.1.2.1.3. Face Equipment

Coal will be excavated from panels by drilling and blasting method. Blast holes will be drilled using pneumatic drilling machines having 1.60m-long auger bits. In panels where the inclination is less than 21°, two different types of hydraulic support will be used for high and low seams.



Figure 37. Coal Driller

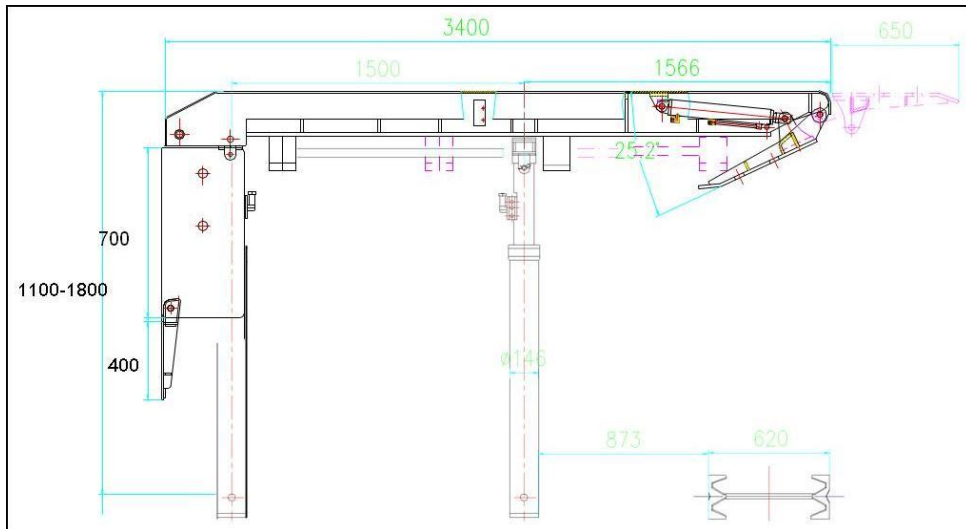

Figure 38. Hydraulic support for low seams (Type-I)

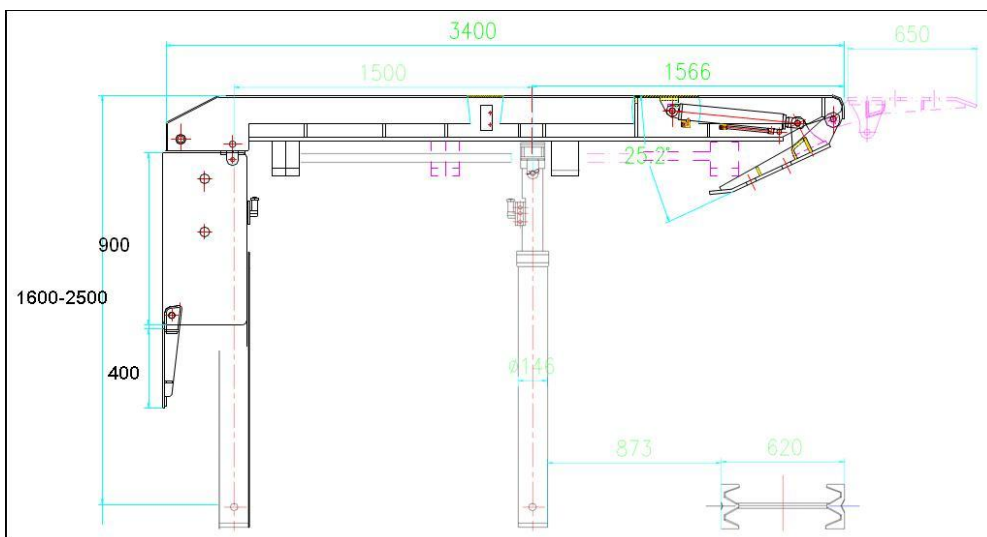

Figure 39. Hydraulic support for high seams (Type-II)

In brief, in the production panels of seams WSC300, WSC400, WSC500 and WSC600 Type-I hydraulic support having operational range of 1.10m-1.80m will be employed as 80 modules. In the production panels of the WSA100 and WSA200 Type-II hydraulic support having 1.60m-2.65m will be employed as 80 modules. The pre-setting load of the hydraulic supports is 500kN. In maingates and tailgates special type hydraulic props will be employed.

It is planned to use 35-40kW-driven, 80m-long double-chain conveyors as face conveyor. Face conveyor will have 85t/h capacity and 0.85m/s speed. Gateway conveyors will have 600mm width and 1.5m/s speed; their motor powers will vary between 135-150kW.

3.1.2.2. WEST BLOCK COALS

SEAM WA100

Seam thickness varies between 0,65m and 4,10m. There is an interburden in the seam and its thickness varies between 0,02m and 0,60m. Face will be operated between 15° and 25°. Operational height of the face will be from 1,10m to 2,30m due seam thickness and the selected cutting machine. Face width will be 220m except two panels having 143m and 165m face width. There will be 7 full-mechanized production panels whose lengths will vary between 1115m to 1837m (Table 28).

The distance between WA100 and WA200 varies between 10m to 45m.

Table 28. Panels of West WA100

PRODUCTION PANELS	COAL THICKNESS (M)	INTERBURDEN THICKNESS (M)	ROOF/FLOOR ROCK TO BE CUT (M)	CUTTING THICKNESS (M)	PANEL LENGTH (M)	FACE LENGTH (M)	R.O.M. DENSITY (TON/M ³)	R.O.M. RESERVE (TON)
WA100-101	1,80	-	-	1,80	1.115	220	1,63	719.710
WA100-102	1,18	0,06	0,11	1,35	1.592	220	1,75	772.533
WA100-103	2,06	0,08	-	2,13	1.592	143	1,65	629.915
WA100-104	1,31	0,09	0,06	1,46	1.837	220	1,70	998.220
WA100-105	1,80	-	-	1,80	1.837	220	1,63	1.184.989
WA100-106	1,55	0,20	0,01	1,76	1.698	220	1,68	1.049.747
WA100-107	0,88	0,21	0,09	1,18	1.325	165	1,79	456.415
TOTAL								5.811.529

SEAM WA200

Seam thickness varies between 0,55m and 3,00m. There is an interburden in the seam and its thickness varies between 0,03m and 0,42m. Face will be operated between 15° and 25°. Operational height of the face will be from 1,10m to 2,30m due seam thickness and the selected cutting machine. Face width will be 220m except two panels having 143m and 165m face width. There will be 7 full-mechanized production panels whose lengths will vary between 1233m to 1955m (Table 29). The distance between WA200 and WA300 varies between 50m to 70m.

Table 29. Panels of West WA200

PRODUCTION PANELS	COAL THICKNESS (M)	INTERBURDEN THICKNESS (M)	ROOF/FLOOR ROCK TO BE CUT (M)	CUTTING THICKNESS (M)	PANEL LENGTH (M)	FACE LENGTH (M)	R.O.M. DENSITY (TON/M ³)	R.O.M. RESERVE (TON)
WA200-108	1,50	-	0,50	2,00	1.233	220	1,87	1.015.869
WA200-109	1,54	-	0,62	2,16	1.710	220	1,93	1.548.399
WA200-110	1,75	0,07	0,45	2,28	1.710	143	1,86	1.022.754
WA200-111	1,60	0,13	0,52	2,25	1.955	220	1,91	1.819.547
WA200-112	1,59	-	0,41	2,00	1.910	220	1,83	1.538.494
WA200-113	2,31	0,37	-	2,68	1.661	220	1,69	1.659.056
WA200-114	2,05	0,06	-	2,11	1.325	165	1,64	758.854
TOTAL								9.362.973

SEAM WA300

Seam thickness varies between 0,75m and 2,50m. There is an interburden in the seam and its thickness varies between 0,01m and 0,25m. Face will be operated between 15° and 25°. Operational height of the face will be from 1,10m to 2,30m due seam thickness and the selected shearer machine. Face width will be 220m except two panels having 143m and 165m face width. There will be 7 full-mechanized production panels whose lengths will vary between 1210m to 1925m (Table 30).

The distance between WA300 and WA400 varies between 10m to 109m.

Table 30. Panels of West WA300

PRODUCTION PANELS	COAL THICKNESS (M)	INTERBURDEN THICKNESS (M)	ROOF/FLOOR ROCK TO BE CUT (M)	CUTTING THICKNESS (M)	PANEL LENGTH (M)	FACE LENGTH (M)	R.O.M. DENSITY (TON/M ³)	R.O.M. RESERVE (TON)
WA300-115	1,65	0,10	-	1,75	1.203	220	1,66	767.382
WA300-116	1,40	-	0,16	1,57	1.680	220	1,77	1.001.900
WA300-117	1,59	0,05	0,08	1,72	1.660	143	1,71	687.073
WA300-118	1,57	0,08	0,01	1,66	1.925	220	1,66	1.167.606
WA300-119	1,29	-	0,04	1,33	1.859	220	1,67	902.762
WA300-120	1,38	0,01	0,15	1,54	1.568	220	1,76	882.503
WA300-121	1,33	-	-	1,33	1.210	165	1,63	428.592
TOTAL								5.837.818

SEAM WA400

Seam thickness varies between 0,75m and 2,45m. There is an interburden in the seam and its thickness varies between 0,05m and 0,50m. Face will be operated between 15° and 25°. Operational height of the face will be from 1,10m to 2,30m due seam thickness and the selected shearer machine. Face width will be 220m except two panels having 143m and 165m face width. There will be 7 full-mechanized production panels whose lengths will vary between 1203m to 1926m (Table 31). The distance between WA400 and WA500 varies between 15m to 110m.

Table 31. Panels of West WA400

PRODUCTION PANELS	COAL THICKNESS (M)	INTERBURDEN THICKNESS (M)	ROOF/FLOOR ROCK TO BE CUT (M)	CUTTING THICKNESS (M)	PANEL LENGTH (M)	FACE LENGTH (M)	R.O.M. DENSITY (TON/M ³)	R.O.M. RESERVE (TON)
WA400-122	1,05	0,10	-	1,15	1.203	220	1,67	508.544
WA400-123	0,94	0,28	0,12	1,33	1.680	220	1,81	894.019
WA400-124	0,97	0,14	0,17	1,28	1.660	143	1,82	548.767
WA400-125	1,08	0,04	0,18	1,30	1.926	220	1,80	980.407
WA400-126	1,67	-	-	1,67	1.859	220	1,63	1.114.311
WA400-127	1,59	-	0,06	1,65	1.568	220	1,68	942.284
WA400-128	2,32	-	0,01	2,33	1.210	165	1,64	732.498
TOTAL								5.720.831

SEAM WA500

Seam thickness varies between 0,80m and 2,50m. There is an interburden in the seam and its thickness varies between 0,10m and 0,18m. Face will be operated between 15° and 25°. Operational height of the face will be from 1,10m to 2,30m due seam thickness and the selected shearer machine. Face width will be 220m except one panel having 165m face width. There will be 5 full-mechanized production panels whose lengths will vary between 1325m to 1956m (Table 32).

The distance between WA500 and WA600 varies between 15m to 30m.

Table 32. Panels of West WA500

PRODUCTION PANELS	COAL THICKNESS (M)	INTERBURDEN THICKNESS (M)	ROOF/FLOOR ROCK TO BE CUT (M)	CUTTING THICKNESS (M)	PANEL LENGTH (M)	FACE LENGTH (M)	R.O.M. DENSITY (TON/M ³)	R.O.M. RESERVE (TON)
WA500-129	1,37	0,20	0,10	1,66	1.710	220	1,76	1.060.009
WA500-130	1,29	0,33	0,06	1,69	1.956	220	1,74	1.210.102
WA500-131	1,50	-	-	1,50	1.910	220	1,63	1.027.389
WA500-132	0,94	-	0,16	1,10	1.660	220	1,77	710.696
WA500-133	1,00	-	0,11	1,11	1.325	165	1,73	417.856
TOTAL								4.426.052

SEAM WA600

Seam thickness varies between 1,10m and 1,35m. There is an interburden in the seam and its thickness varies between 0,20m and 0,50m. Face will be operated between 15° and 25°. Operational height of the face will be from 1,10m to 2,30m due seam thickness and the selected shearer machine. Face width will be 275m. There will be 1 full-mechanized production panel whose length will be 1956m (Table 33).

The distance between WA600 and WA700 varies between 95m to 130m.

Table 33. Panels of West WA600

PRODUCTION PANELS	COAL THICKNESS (M)	INTERBURDEN THICKNESS (M)	ROOF/FLOOR ROCK TO BE CUT (M)	CUTTING THICKNESS (M)	PANEL LENGTH (M)	FACE LENGTH (M)	R.O.M. DENSITY (TON/M ³)	R.O.M. RESERVE (TON)
WA600-134	0,80	0,13	0,24	1,16	1.956	275	1,88	1.173.751
TOTAL								1.173.751

SEAM WA700

Seam thickness varies between 0,70m and 2,45m. There is an interburden in the seam and its thickness varies between 0,15m and 0,60m. Face will be operated between 15° and 25°. Operational height of the face will be from 1,10m to 2,30m due seam thickness and the selected shearer machine. Face width will be 220m except two panels having 143m and 137m face width. There will be 5 full-mechanized production panels whose lengths will vary between 1710m to 1956m (Table 34).

Table 34. Panels of WA700

PRODUCTION PANELS	COAL THICKNESS (M)	INTERBURDEN THICKNESS (M)	ROOF/FLOOR ROCK TO BE CUT (M)	CUTTING THICKNESS (M)	PANEL LENGTH (M)	FACE LENGTH (M)	R.O.M. DENSITY (TON/M ³)	R.O.M. RESERVE (TON)
WA700-135	1,06	0,40	0,02	1,77	1.710	220	1,77	981.902
WA700-136	1,10	0,39	0,10	1,83	1.710	143	1,83	684.414
WA700-137	1,85	0,47	-	1,72	1.956	220	1,72	1.673.778
WA700-138	1,42	0,17	-	1,68	1.910	220	1,68	1.119.182
TOTAL								4.459.276

After a panel is finished, equipments will be overhauled in order to work properly and than transported to the new panel and installed. It is planned to perform these works within 45 days. Production target in these panels is 6000ton/day if shearer loader or 3500ton/day if plow is used.

130 personnel will be employed for the full-mechanized production panels of the WA100, WA300, WA400, WA500 and WA700. Advance rate will be 8,61m/day and 258m/month and face efficiency will be 26,9ton/man-wage. In the calculations, minimum cutting height is assumed to be 1,10m and density is assumed to be 1,68ton/m³.

130 personnel will be employed for the full-mechanized production panels of the WA200. Advance rate will be 9,01m/day and 271m/month and face efficiency will be 46,2ton/man-wage. In the calculations, minimum cutting height is assumed to be 2,00m and density is assumed to be 1,68ton/m³.

130 personnel will be employed for the full-mechanized production panels of the WA600. Advance rate will be 6,88m/day and 207m/month and face efficiency will be 46,2ton/man-wage. In the calculations, minimum cutting height is assumed to be 1,10m and density is assumed to be 1,68ton/m³.

In West Block, totally 47 full-mechanized panel have been planned in 7 coal seams between Central Fault and Fault No.3. (See Appendix-11)

3.1.2.1. MINING METHOD TO BE APPLIED IN WEST PRODUCTION BLOCK

In West Block, production panels are named as WA100-101, W100-102 and so on from north to south. Longwall faces will be operated as single cut, retreat and back-caving. Mining method will be same with East Block.

Double drum shearer will cut coal seams having 2,0m thickness and 1,68 ton/m³ density. Cutting capacity will be maximum 1500ton/hour. In WA100, 300, 400, 500, 600 and 700, plow will cut coal seams having 1,1m thickness and 1,68 ton/m³ density. Cutting capacity will

be maximum 750ton/hour. Coal will be loaded to AFC and conveyed to stage loader. Particle size will be reduced to desired size with the crusher mounted on the stage loader. From stage loader coal will be loaded to belt conveyor and transported to the shaft bottom.

Face will be supported with minimum 1000mm maximum 2500mm-high powered roof supports.

3.1.2.2. FACE EQUIPMENT TO BE USED IN WEST PRODUCTION BLOCK

In West Block, the cross sectional views of a powered roof support to be used in longwall panels of WA100, WA300, WA400, WA500, WA600 and WA700 are shown on the below figures (Figure 40, Figure 41, Figure 42, Figure 43).

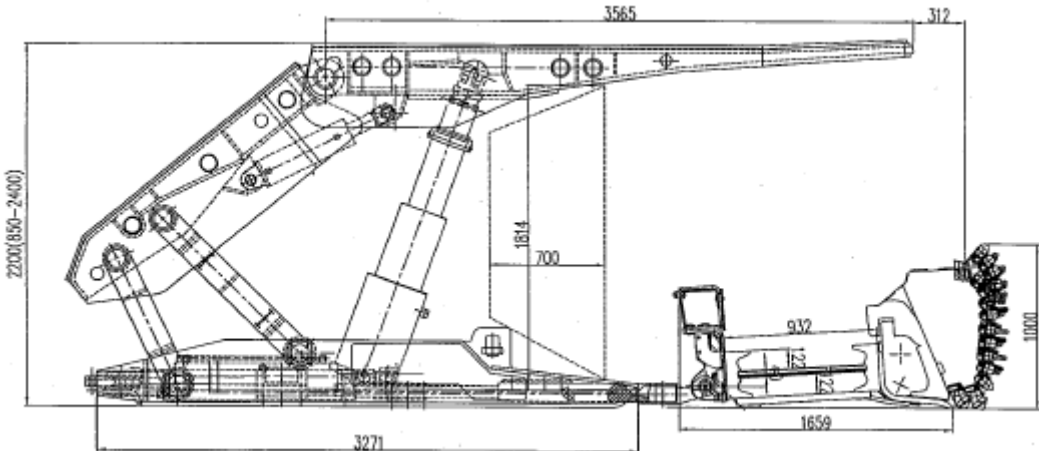

Figure 40. Cross section of powered roof support with plow-1

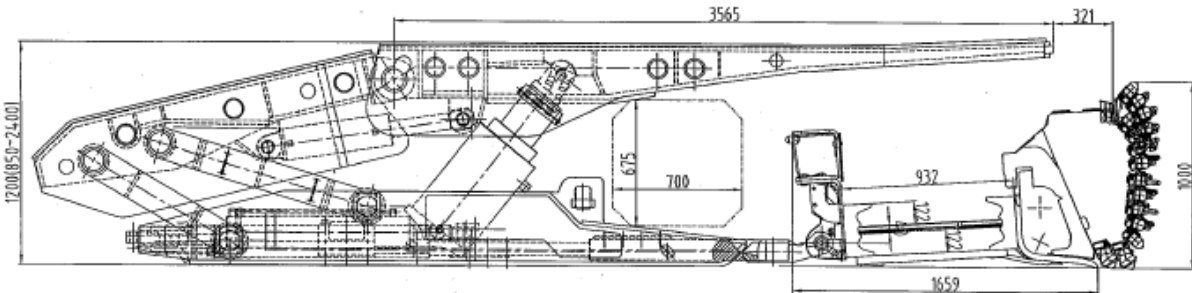

Figure 41. Cross section of powered roof support with plow-2

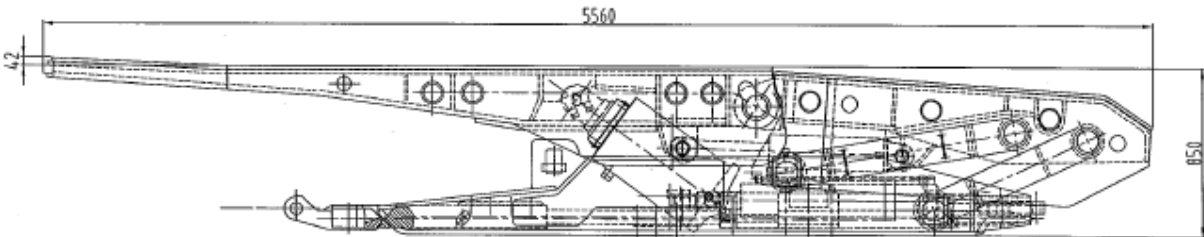

Figure 42. Cross section of powered roof support

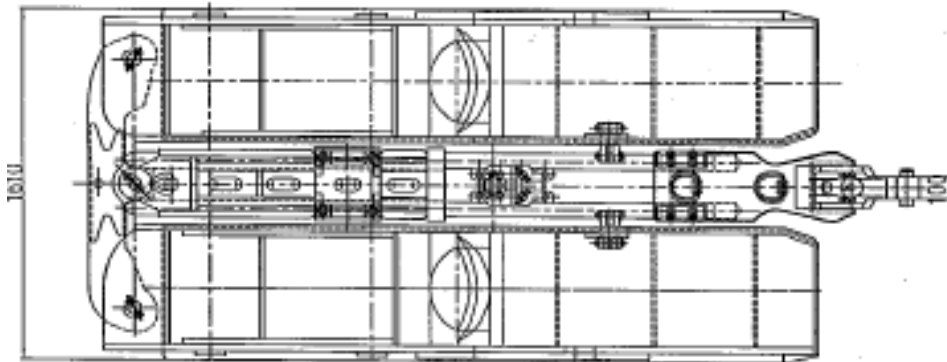

Figure 43. Plan view of powered roof support

In the production face, 160-167 pcs powered roof supports will be used. Minimum and maximum height of supports is 1,00m and 2,50m. Operating range of these powered roof supports is 1,10m-2,30m. An individual support will have 1,5m center to center width and its weight will be app. 17ton. Yield load and support resistance of roof supports will be according to calculations in Article 2.6. Special type of transition shield and gate road shield in tailgate and transition between gateway and face may be used.

Control system of the powered roof supports will be 12-14 functioned, electro-hydraulic controlled.

In West Block, the cross sectional views of a powered roof support and the 2x400 kW capacity plow to be used in longwall panels of WA100, WA300, WA400, WA500 and WA600 are shown on Figure 40.

In the production face, 160-167 pcs powered roof supports will be used. Minimum and maximum height of supports is 1,00m and 2,50m. Operating range of these powered roof supports is 1,10m-2,30m. An individual support has 1,50m center to center width and its weight will be app. 17ton. Yield load and support resistance of roof supports will be according to calculations in Article 2.6. Special type of transition shield and gate road shield in tailgate and transition between gateway and face may be used.

In West Block, estimated specifications of beam stage loader and AFC will be as follows: Double-chain stage loader will be used in the faces where shearer or plow to be used. Power of drive units of stage loaders will be app. 400 kW power. Capacity of the stage loader will be 1500ton/h. Capacity of the AFC will be 1200ton/h and it will be driven by 2x400 kW power.

On both conveyors, tension units will be mounted. Tension of the chain will be adjusted automatically by tension units. Transfer of coal from AFC to stage loader will be performed by side-dump-chute. A 200 kW-power and 2000ton/h-capacity crusher will be mounted on the stage-loader (Figure 27).

3.1.2.3. PACK WALL SYSTEM TO BE APPLIED IN MAINGATES OF WEST PRODUCTION BLOCK

Packing system to be applied in West Block will be the same with East Block.

After supported and maintained, maingate of a panel will serve as the tailgate of next panel. It will be supported with pack walls in order to reduce the deformations to the gateway supports caused by the stresses. Recommendation from the similar operations, the width of pack walls will around 4m and height will be the same with the excavated height (Figure 20).

Four silo having 100ton capacity will be constructed on surface inclined gallery entrance location.1 surface layout for packing system. Two of them will be used for cement and ash storage and the remaining two will be used for mixture storage. Mixture will be prepared from electro-filtered ash and cement (30%). Ash will be obtained from thermal power plant to be founded. Since then, the raw material for packing system will be supplied from storage silos. The dry mixture from the silos will be sent to -510 underground subsilo through pipes with compressed air. Water will be added to the dry mixture in this subsilo. Water added mixture will be pumped to the gateways by concrete pump from the subsilo. Neutral sodium-silicate at 1,5-2% will be used as setting accelerator

3.1.3. SOUTHEAST BLOCK COAL SEAMS AND PRODUCTION PLANNING

Production project covers an area of 4,1km² in Southeast Block. Area of our interest in Southeast Block is the part surrounded by the Central Fault at the west and Fault No.2 at the North and Figure 44.

In Southeast Block, in Karadon formation there are 2 coal seams having recoverable thickness and are said to be Westphalia-C aged in the zone descended under the influence of the Central Fault. These seams exist between -660 and -890 levels and are given the names SEC400 and SEC500 from top to the bottom, respectively. In this area, seams having minimum 0,95m thickness have been assumed to be the recoverable. Correlation studies of Westphalia-A aged seams below SEC500 are still on progress (Figure 44).

Reserve of the full-mechanized panels is app. 21 million ton. Reserve of panels where inadequate data and unrecoveryable seam thickness occurs is not included to reserve calculations. Seam inclinations vary between 10° and 15°.

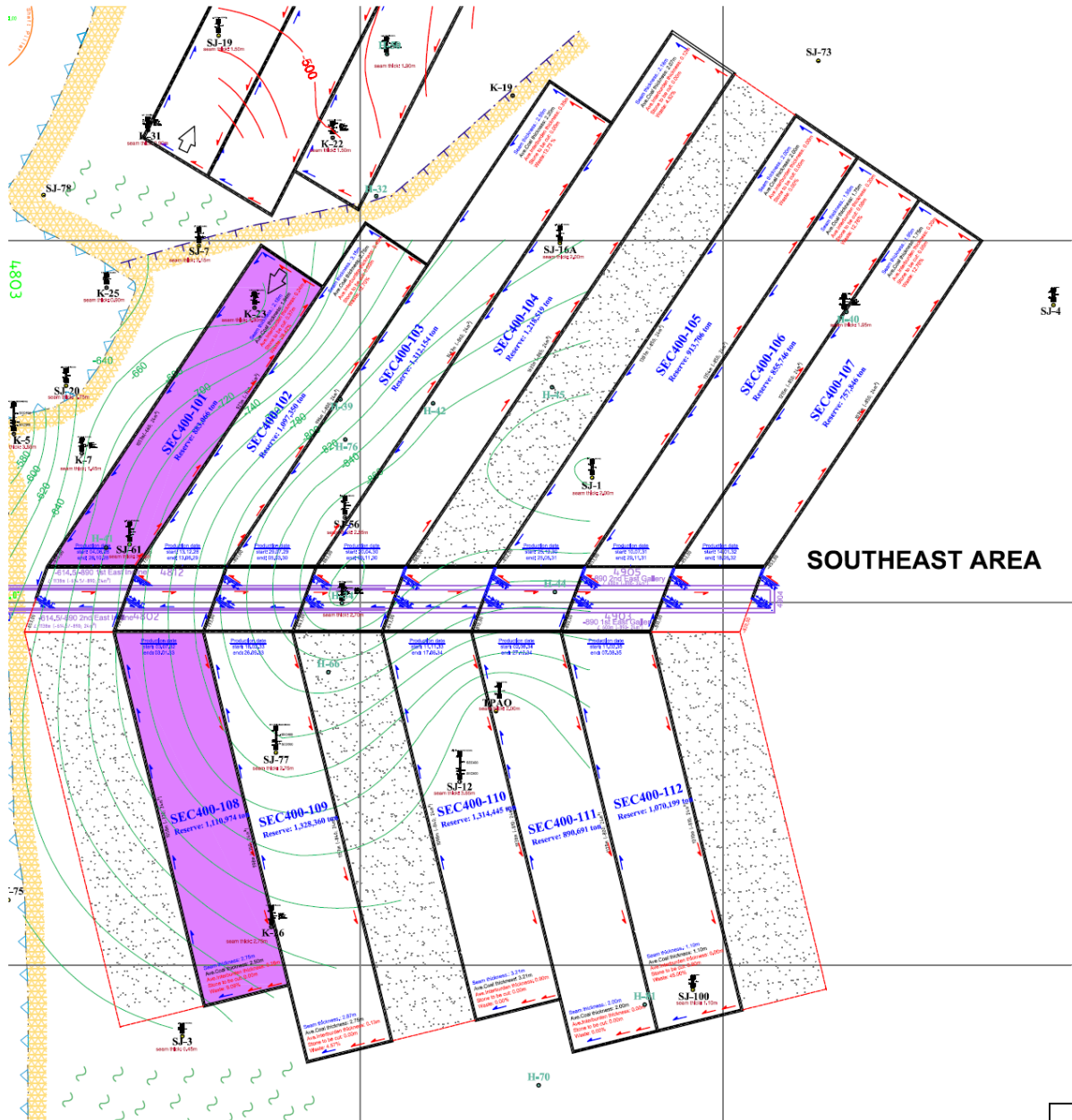

Figure 44. Southeast Production Block

SEAM SEC400

Seam thickness varies between 1,30m and 3,65m. There is an interburden in the seam and its thickness varies between 0,10m and 0,40m. Face will be operated between 10° and 15°. Operational height of the face will be from 2,00m to 4,00m due seam thickness and the selected shearer machine. Face width will be 207m in 8 panels and 242m in the remaining 7 panels. There will be 12 full-mechanized production panels whose lengths will vary between 923m to 1631m (Table 35).

The distance between SEC400 and SEC500 varies between 0,40m to 15m. Although these two seams are getting close to each other at some parts, they will be produced separately. When developing the gateways of SEC400 hanging wall will be cut rather than its footwall and vice-versa for SEC500 in order not to disturb the pillar between the two seams.

Table 35. Production Panels of Southeast SEC400

PRODUCTION PANELS	COAL THICKNESS (M)	INTERBURDEN THICKNESS (M)	ROOF/FLOOR ROCK TO BE CUT (M)	CUTTING THICKNESS (M)	PANEL LENGTH (M)	FACE LENGTH (M)	R.O.M. DENSITY (TON/M ³)	R.O.M. RESERVE (TON)
SEC400-101	1,94	0,24	0,37	2,55	923	207	1,85	883.066
SEC400-102	2,75	0,40	-	3,15	996	207	1,69	1.097.350
SEC400-103	2,20	0,35	-	2,55	1.467	207	1,69	1.312.154
SEC400-104	2,07	0,12	-	2,18	1.631	207	1,65	1.218.519
SEC400-105	2,00	-	-	2,00	1.354	207	1,63	913.706
SEC400-106	1,75	0,20	0,05	2,00	1.215	207	1,70	855.746
SEC400-107	1,75	0,20	0,05	2,00	1.076	207	1,70	757.846
SEC400-108	2,50	0,25	-	2,75	998	242	1,67	1.110.974
SEC400-109	2,75	0,13	-	2,87	1.157	242	1,65	1.328.360
SEC400-110	3,21	-	-	3,21	1.038	242	1,63	1.314.445
SEC400-111	2,00	-	-	2,00	1.129	242	1,63	890.691
SEC400-112	1,10	-	0,90	2,00	1.070	242	2,07	1.070.199
TOTAL								12.753.056

SEAM SEC500

Seam thickness varies between 1,00m and 2,15m. There is an interburden in the seam and its thickness varies between 0,03m and 0,75m. Face will be operated between 10° and 15°. Operational height of the face will be from 1,10m to 2,30m due seam thickness and the selected shearer machine. Face width will be 191m at 8 panels and 242m at 7 panels. There will be 15 full-mechanized production panels whose lengths will vary between 923m to 1631m (Table 36).

Since the SEC400 and SEC500 will be produced separately, the gateways of these two seams will not be in line in the vertical plane and the footwall will be cut during gateway development of SEC500 to avoid a connection with the gob areas of the upper seam. It means the shearer will cut footwall rock for a 10m long part at the beginning per panel during production.

In Southeast Block, totally 23 full-mechanized panel have been planned in 2 coal seams at the south of Fault No.2 (*See Appendices-12*)

Table 36. Production Panels of Southeast SEC500

PRODUCTION PANELS	COAL THICKNESS (M)	INTERBURDEN THICKNESS (M)	ROOF/FLOOR ROCK TO BE CUT (M)	CUTTING THICKNESS (M)	PANEL LENGTH (M)	FACE LENGTH (M)	R.O.M. DENSITY (TON/M ³)	R.O.M. RESERVE (TON)
SEC500-113	1,05	0,03	0,05	1,13	923	207	1,68	361.902
SEC500-114	1,00	-	0,10	1,10	996	207	1,72	389.665
SEC500-115	1,65	0,25	-	1,90	1.476	207	1,69	982.133
SEC500-116	1,42	0,08	-	1,50	1.631	207	1,65	839.091
SEC500-117	1,40	0,75	-	2,15	1.354	207	1,79	1.081.032
SEC500-118	1,05	0,60	-	1,65	1.215	207	1,80	747.347
SEC500-119	1,05	0,60	-	1,65	1.076	207	1,80	661.848
SEC500-120	1,50	-	-	1,50	998	242	1,63	590.507
SEC500-121	1,25	-	0,05	1,30	1.157	242	1,67	607.680
SEC500-122	1,16	-	0,04	1,20	1.038	242	1,66	501.083
SEC500-123	1,50	-	-	1,50	1.129	242	1,63	668.018
TOTAL								7.430.306

After a panel is finished, equipments will be overhauled in order to work properly and then transported to the new panel and installed. It is planned to perform these works within 45 days. Production target in these panels is 6000ton/day if shearer loader or 3500ton/day if plow is used.

130 personnel will be employed for the full-mechanized production panels of the SEC400. Advance rate will be 9,58m/day and 288m/month and face efficiency will be 46,2ton/man-wage. In the calculations, minimum cutting height is assumed to be 2,00m and density is assumed to be 1,68ton/m³.

130 personnel will be employed for the full-mechanized production panels of the SEC500. Advance rate will be 9,14m/day and 274m/month and face efficiency will be 26,9ton/man-wage. In the calculations, minimum cutting height is assumed to be 1,10m and density is assumed to be 1,68ton/m³.

3.1.3.1. MINING METHOD TO BE APPLIED IN SOUTHEAST PRODUCTION BLOCK

In Southeast Block, production panels are named as SEC400-101, SEC400-102 and so on from north to south. Longwall faces will be operated as single cut, retreat and back-caving. Face width will vary between 207m and 242m and panel length will be 788-1681m.

In SEC400, double drum shearer will cut coal seams having 4,0m (max.) and 1,68 ton/m³ density. Cutting capacity will be at least 1900ton/hour. Coal will be loaded to AFC which has at least 2000ton/hour capacity. Face will be supported with minimum 2000m high power supports.

In SEC500 plow will cut coal seams having 1.1m (max.) and 1,68 ton/m³ density. Cutting capacity will be at least 1500ton/hour. Coal will be loaded to AFC which has at least 2000ton/hour capacity. Face will be supported with minimum 1000m high power supports.

Coal will be loaded to AFC and conveyed to stage loader. Particle size will be reduced to desired size with the crusher mounted on the stage loader. From stage loader coal will be loaded to belt conveyor and transported to the shaft bottoms.

3.1.3.2. FACE EQUIPMENT OF SOUTHEAST PRODUCTION BLOCK

In Southeast Block, the cross sectional views of a power support to be used in longwall panels of SEC400 are shown on the Figure 23, Figure 24, Figure 25 and that of SEC500 are shown on Figure 40, Figure 41, Figure 42, Figure 43. Powered roof supports and shearer loaders will be transferred from East and West Blocks after the production activities are completed there.

In the production panels of SEC400, 158 (2000-4500 mm) powered roof supports and in that of SEC500, 164 (1000-2500 mm) powered roof supports will be used.

3.1.3.3. PACKWALL SYSTEM TO BE APPLIED IN MAINGATES OF SOUTHEAST PRODUCTION BLOCK

Packing system to be applied in Southeast Block will be the same with East Block. After supported and maintained, maingate of a panel will serve as the tailgate of next panel. It will be supported with pack walls. Recommendation from the similar operations, the width of pack walls will around 4m and height will be the same with the excavated height (Figure 20).

Packing system units of East Block at Shaft No.1 will be transferred to the shaft No.2 after the production activity in East Block is completed.

Four silos having 100ton capacity will be constructed on Shaft No.2 surface layout for packing system. Two of them will be used for cement and ash storage and the remaining two will be used for mixture storage. Mixture will be prepared from electro-filtered ash and cement (30%). Ash will be obtained from thermal power plant to be founded. Since then, the raw material for packing system will be supplied from storage silos.

The dry mixture from the silos will be send to -610 underground subsilo through pipes with compressed air. Water will be added to the dry mixture in this subsilo. Water added mixture will be pumped to the gateways by concrete pump from the subsilo. Neutral sodium-silicate at 1,5-2% will be used as setting accelerator.

3.2. RESERVE AND TIMELINES OF PRODUCTION AREAS

Panel designs are done according to be at zones isolated by big faults.

Hoist shaft locations are selected according to be outside of the production panel zones.

Field is divided into two (East and West) by Central Fault. East Block boundary is Fault No.2 in South and Tuna Fault in North. West Block boundary is Fault No.3 in North and sterile zone in South. Southeast Block boundary is Fault No.2 in North and sterile zone in South. Shafts and galleries are projected according to serve these Blocks.

In East Block, production will be commneced with mechanized panel in April 2015. In West Block, production will be started in June 2017. In Southeast Block, start date of production will be June 2028.

Production panels and reserve tables have been prepared Block by Block and seam by seam.

Detailed panel reserves are given as Appendix-15.

3.3. PRECAUTIONS TO REDUCE RISKS IN PRODUCTION

3.3.1. RISK OF COAL SEAMS

It is possible to encounter risks of coal seam thickness reduction, inclination variations, structural faults (faults and joints) during coal production.

In order to reduce these risks, to have more data, current drilling programme is intensified at areas where production will be done. Thicknesses, chemical properties and dips of coal seams at roof and flor will be identified with underground drillings which will be held during gallery openings. Moreover, in order not to affect production process necessary precautions will be taken with the advantage of retreat longwall mining method -identifying thicknesses and dips of coal seams and faults if any during rise headings and gateways. Risks of excavation and mechanization will be reduced with rock mechanics tests of roof and floor rocks of coal seam.

3.3.2. RISK OF GAS AND DUST OUTBURST

In order to eliminate risks of gas and dust outburst, check borehole drillings will be done with 50 meters length at galleries in coal and stone through out the mine in all production levels.

During development works, check borehole drillings will be done towards tailgate from maingate. Drill hole interval is planned as 100 meters along maingates. Moreover, pressure changes, methane emission in mine, gas characteristics and explosion risk will be evaluated together with electronic systems. Real time personel locations and emergency communication systems will be installed.

3.3.3. RISK OF SPONTANEOUS COMBUSTION

Spontaneous combustion in underground coal mines is a well known world wide issue. Molecular structure and spontaneous combustion risk of our coal is investigated with laboratory studies. Based on these studies, spontaneous combustion risk in micro scale is evaluated and spontaneous combustion risk of our coals is identified as “medium”.

Due to spontaneous combustion risk of Amasra coals, real time CO emission measurement will be done. In order to watch CO emission that might be caused by production activities, sensors will be located in gateways and face ends. Measurements will be controlled 24 hours with central monitoring system.

To reduce fire risk, nitrogen injection will be done in areas where spontaneous combustion is determined. Thus, those surfaces will be cooled and contact with air will be prevented.

Ash and cement will be transported with pneumatic pipeline to silos close to production Block from surface silos in order to eliminate panel fires. Ash and cement of silos close to production Blocks will be mixed with water and pumped to gob areas with injection pumps. Thus, coal in gobs will be cooled and air contact will be prevented.

3.3.4. WORKER’S TRAINING RELATED TO WORK ACCIDENTS

Traumatic injuries in underground mines is a big issue. Loss of job happens because of common rock falls, fires, explosions, shocks and accidents related with moving equipment. Awareness-raising trainings will be held continiously and systematically.

3.3.5. SUBSIDENCE EFFECT TO DUE PRODUCTION

Settlements located above the projected production areas are given in Appendix-35. As it is seen in Appendix-35, Bostanlar village, Karayusuflar and Camlık quarters are located above East production Block.

Coal will be produced at levels between -450 and -500 under these settlements. Settlements’ levels are between +250 and +300 which means the production will take place 700-800 meters deep. It is been calculated that 54-64 cm subsidence may occur after 8-10 years.

Under these circumstances, it is planned to expropriate those settlements. Costs of expropriations are listed in investment items.

“Filling” will be done to minimize the subsidence. There is no settlement above West production Block. In southeast, production will be done 900 meter deeper than settlements level. In case any subsidence occurs in this Block, those areas will be expropriated.

3.4. PRODUCTION BY YEARS

Annual production tables block by block basis as well as gateway distribution is given in Appendix-18.

3.4.1. OVERALL PRODUCTION

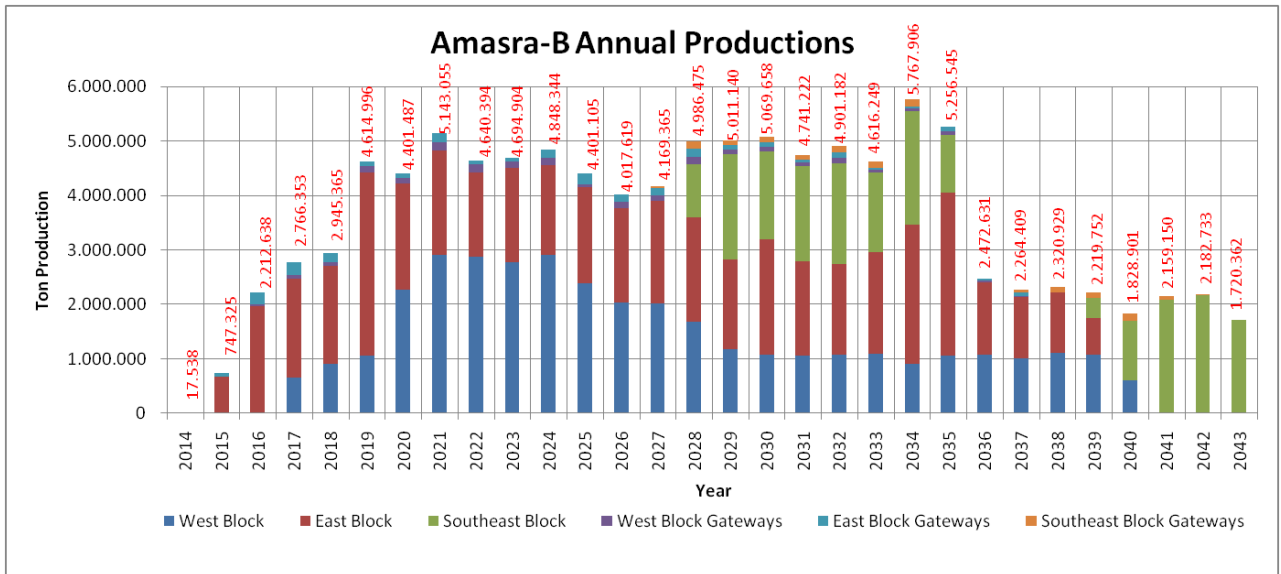

Graph 1. Overall Production Graph

3.4.2. EAST BLOCK PRODUCTION

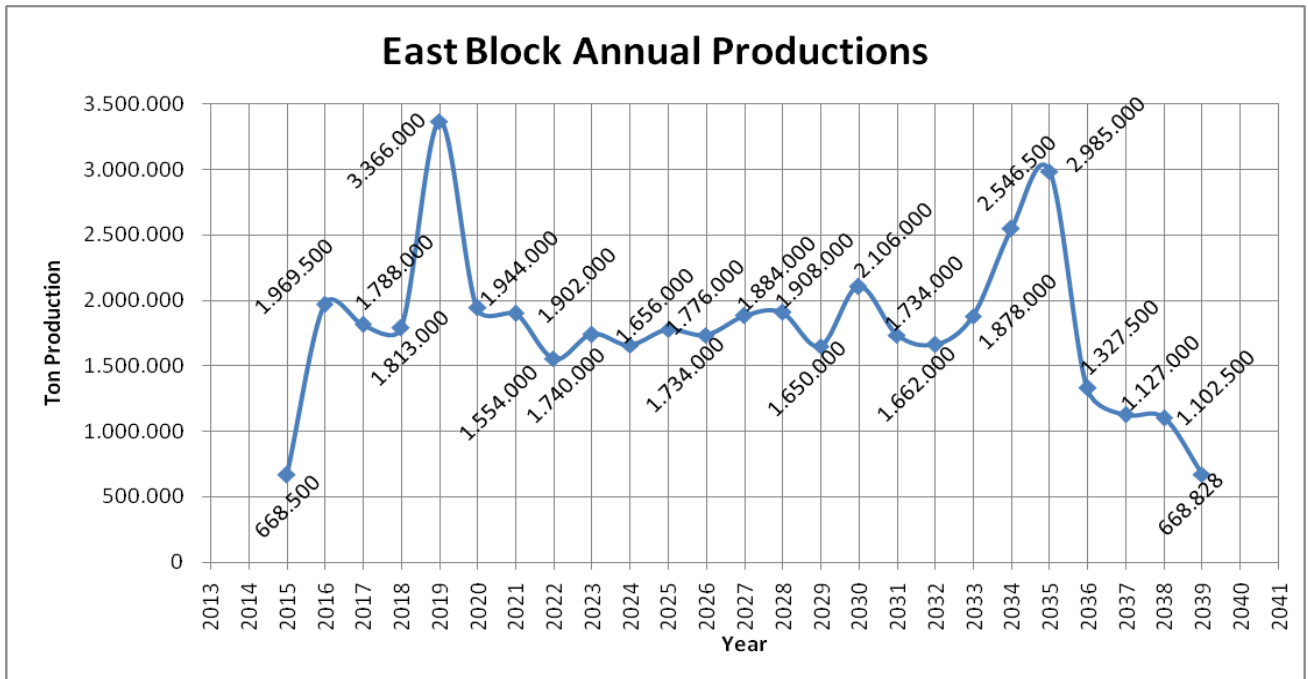

Graph 2. East Block Annual Production Graph

3.4.3. WEST BLOCK PRODUCTION

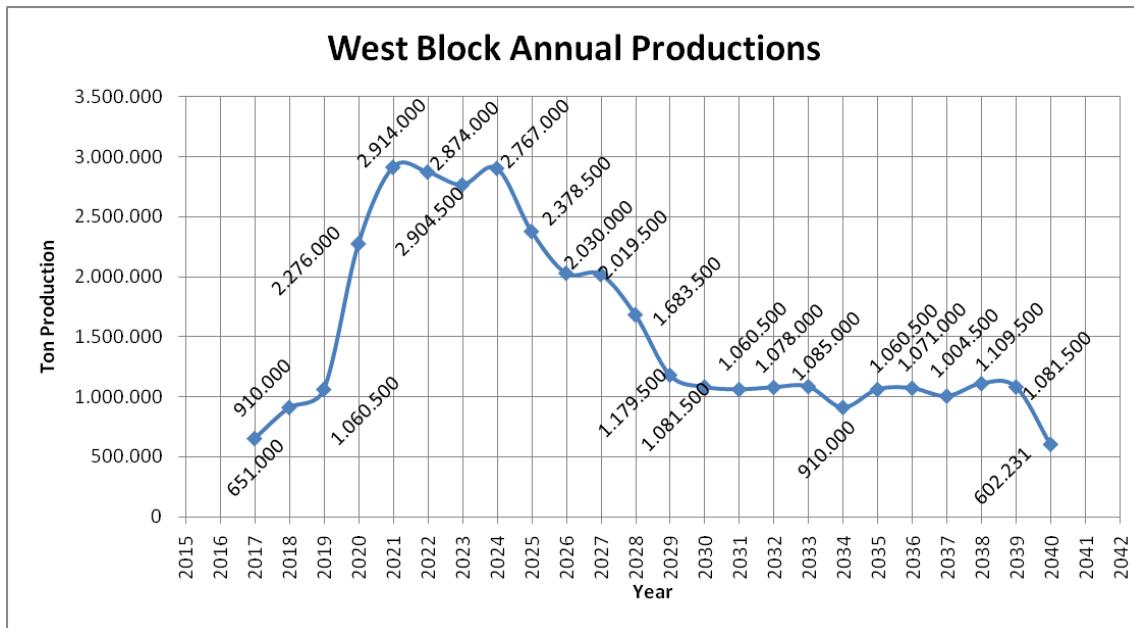

Graph 3. West Block Annual Production Graph

3.4.4. SOUTHEAST BLOCK PRODUCTION

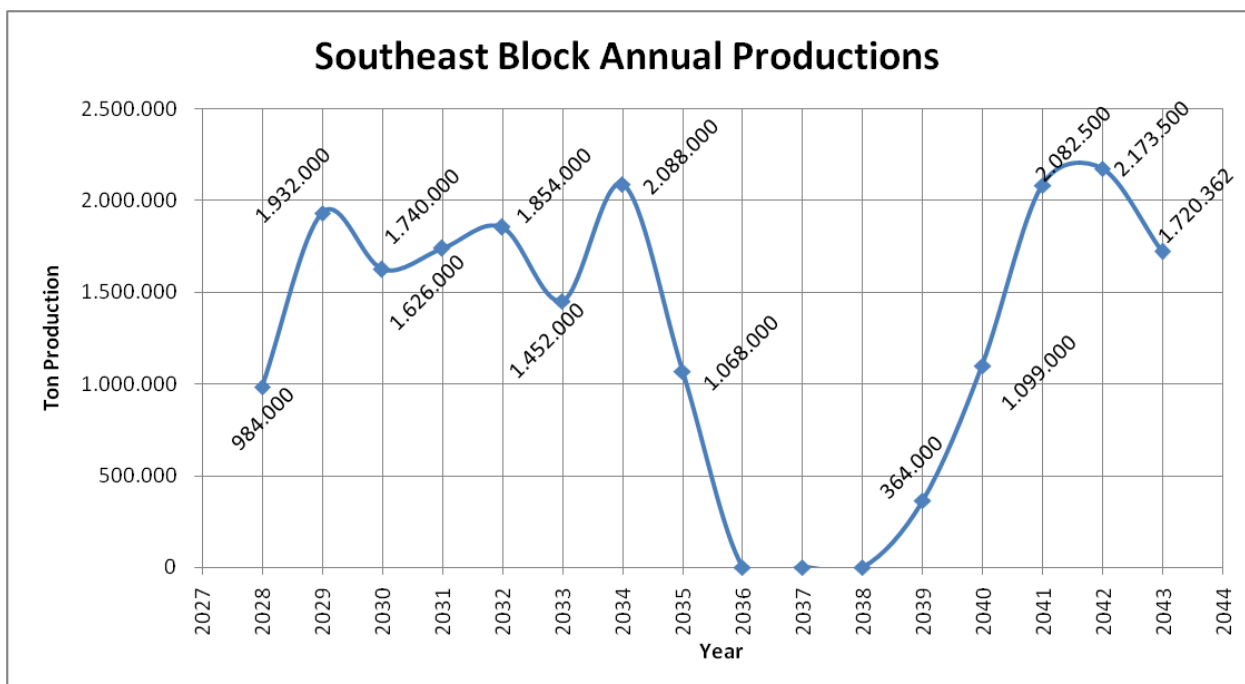

Graph 4. Southeast Annual Production Graph

3.4.5. SHALLOW COAL PRODUCTION

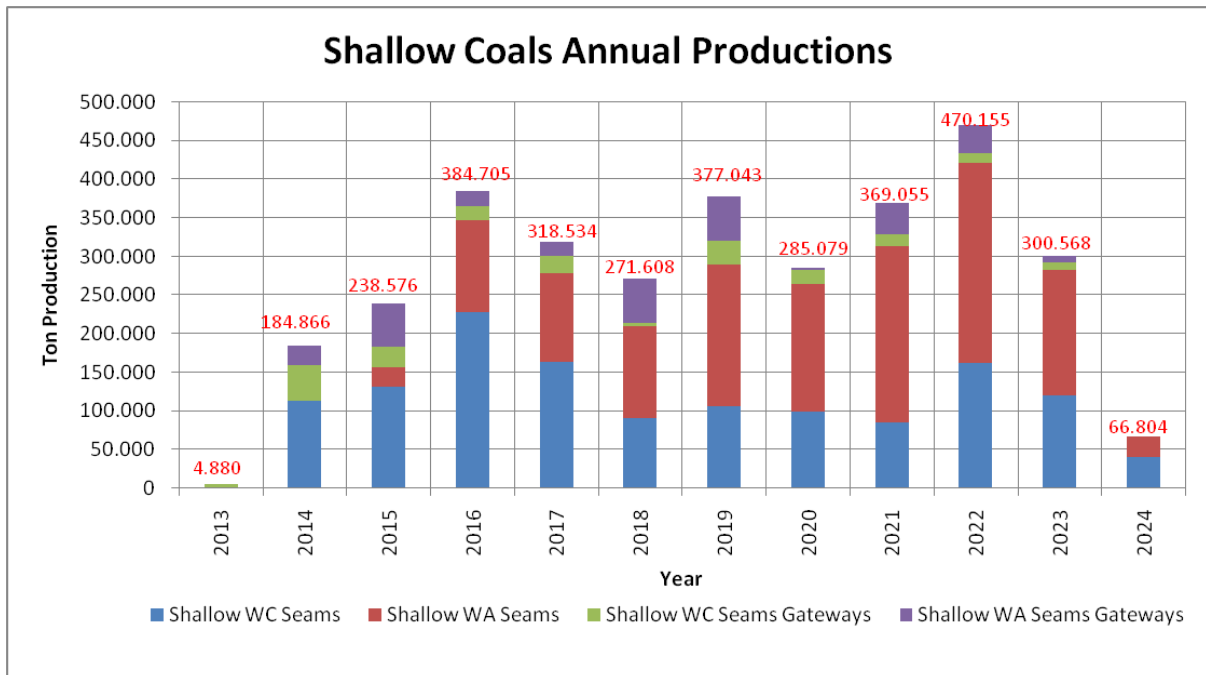

Graph 5. Shallow Coals Annual Production Graph

3.4.6. GATEWAYS PRODUCTION

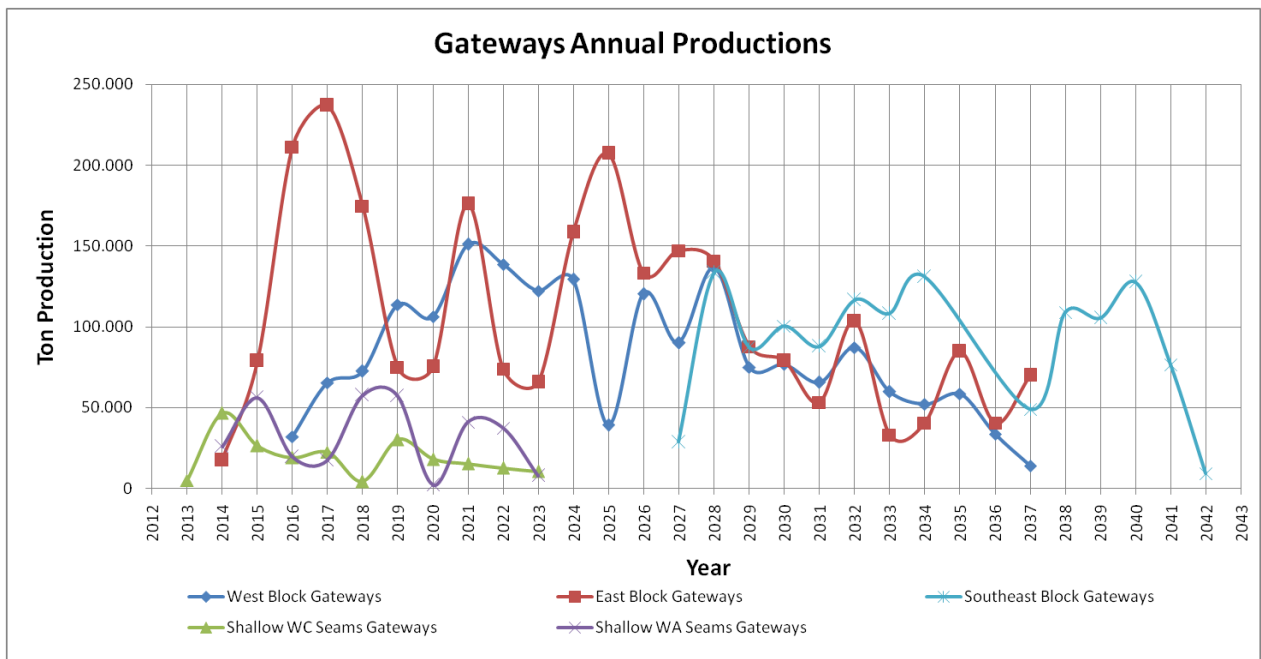

Graph 6. Gateways Annual Production Graph

3.5. GATEWAY EQUIPMENT LIFE

First revision of roadheaders will be done at first 8000m, second revision at 14000m, and third revision at 20000m. Investments are planned according to expiration period of roadheaders as 24000m. 6 roadheader purchases are planned in required years for the gateway openings of full mechanized panels.

3.6. FACE EQUIPMENT LIFE

Expiration period of powered supports is 30000 displacements (21000m advancement). Powered supports, which will work with shearer loader, are planned as two panels. Considering panel advancement during project life, powered support for four panel is required and they will be purchased in years when necessary. Powered supports, which will work with plow, are planned as two panels. Considering panel advancement during project life, powered support for four panel is required and they will be purchased in years when necessary.

Shearer loader revision will be done at 5 million ton with 60% expense, at 10 million ton with 60% expense. Shearer loader life expiration is planned as after 14 million ton. 4 pcs of shearer loaders will be purchased in years when necessary. 3 pcs of plow will be purchased in years when necessary. Head and tail chutes of trunk and face conveyor will be changed after 14 million ton. Thus app. 7 sets of trunk conveyor and 7 sets of head and tail chutes will be purchased. Middle chutes will be changed after 4 million ton. 150 pcs chutes (1,5m) are necessary for 204m face and 35 trunk conveyor. App. 3450 pcs chutes will be purchased in necessary years since chutes will be changed 23 times during project.

4. MINE VENTILATION

4.1. MAIN PRINCIPLES OF VENTILATION

6-13 m³/ton in-situ methane is measured in coal at production areas according to a geological assessment for Zonguldak basin was prepared for CBM potential upon request of TTK. This data has been considered in ventilation calculations.

According to this assessment, specific emissions of Karadon and Kozlu District colliery drifts was measured between 10,1-11,5 m³/ton mined in 1997 (Table 37).

Table 37. Liberated Methane Measurement at TTK Colliery Drifts in 1997

Mining District	Annualized Methane Liberated (m³)	Annualized Coal Production (tonnes)	Specific Emissions (m³/ton mined)
Karadon District	7.746.683	675.074	11,5
Kozlu District	14.130.940	1.400.482	10,1
Average	21.877.62.3	2.075.556	10,5

As seen in Figure 45, considering methane concentration at 160 meter upper seam, 60 meter lower seam and surrounding strata, total methane emission will be 16 m³ per ton (Figure 45).

According to the production plan, annual production is 3,5-5,5 million ton and daily production is 10.000-15.700 ton.

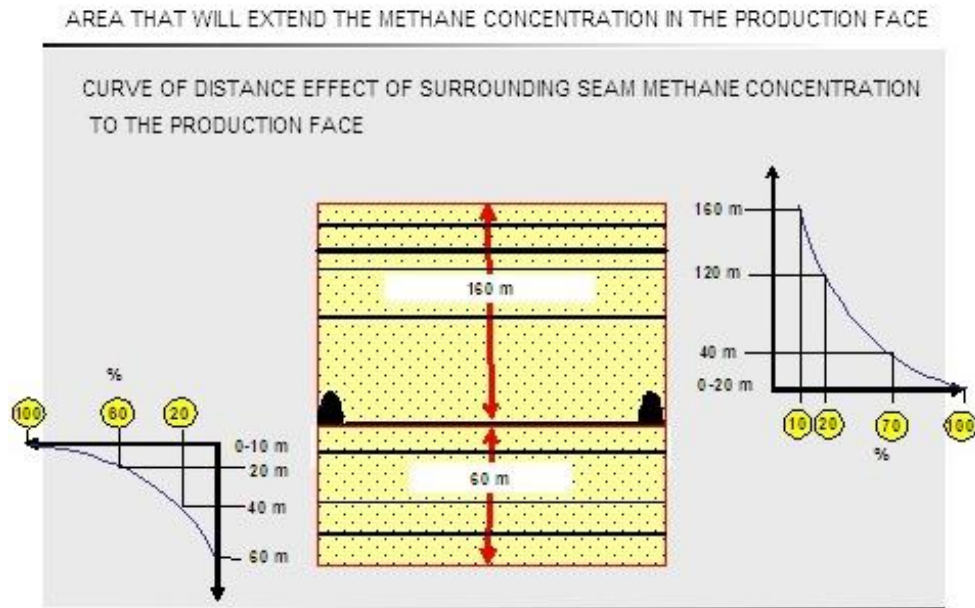

Figure 45. Curve of Distance Effect of Surrounding Seam Methane Concentration to the Production Face

4.2. EXHAUST FANS THAT WILL BE USED IN MAIN VENTILATION

Ventilation of First Block will be supplied by two exhaust fans. These fans will be installed at Shaft No.3. Exhaust fan will work with 4800-9000 Pascal depression and up to 430 m³/sec flow rate.

Ventilation of Second Block will be supplied by two exhaust fans as well. These fans will be installed at entrance of No.3053 gallery at Shaft No.1 surface. Fan, will work with 6000 Pascal depression and 200 m³/sec flow rate. Fan model is Turmag GVhv32-2000-2w with 10000 V voltages and 2100 kW AEG motor attached (Appendix-38).

4.3. VENTILATION PLAN

The ventilation plans have been redesigned to match the new mining layout. The key points of these plans are as follows:

- East Production Block (First Operation Field) - The ventilation plan uses Shaft No.1 for intake air and Shaft No.3 for return. Shaft No.3 will be equipped with two ventilation fans (1 main and 1 for spare). These fans have been purchased and will be delivered to Amasra by the end of November 2013. HEMA have detail plans for the fan house installation (Appendix-16/17).
- West Production Block (Second Operation Field) - The ventilation plan uses Shaft No.2 for intake air and inclined ventilation gallery for return. The existing design has been modified to meet the higher capacity requirements for the ventilation of this area of mining. The fans have been purchased and are at site. The details of the ventilation are shown in Appendix-57 and Figure 46. The building plan is on design and is scheduled for completion in December 2013.
- Southeast Production Block (Third Operation Field) - Production from Southeast Block is currently scheduled to start in 2028. Ventilation system will utilise the same infrastructure that is been provided for West Production Block.

In designing the ventilation requirements for each mining area HEMA have taken account of the Turkish Mining Regulations, the anticipated methane emissions from each of the seams in the respective areas, the assumed level of methane drainage capture, maximum acceptable velocities and international good practice. The key design parameters include:

- Maximum 0,87% methane in all return roadways
- Maximum 1,25% methane in production face
- Two simultaneously working longwalls (12.000tons/day for East and Southeast and 7.000tons/day)
- 5 m³/ton methane emission during mining after drainage
- Ventilation velocity within the regulated limits

The ventilation layout and summary network calculations are attached as Appendices-57/58/59.

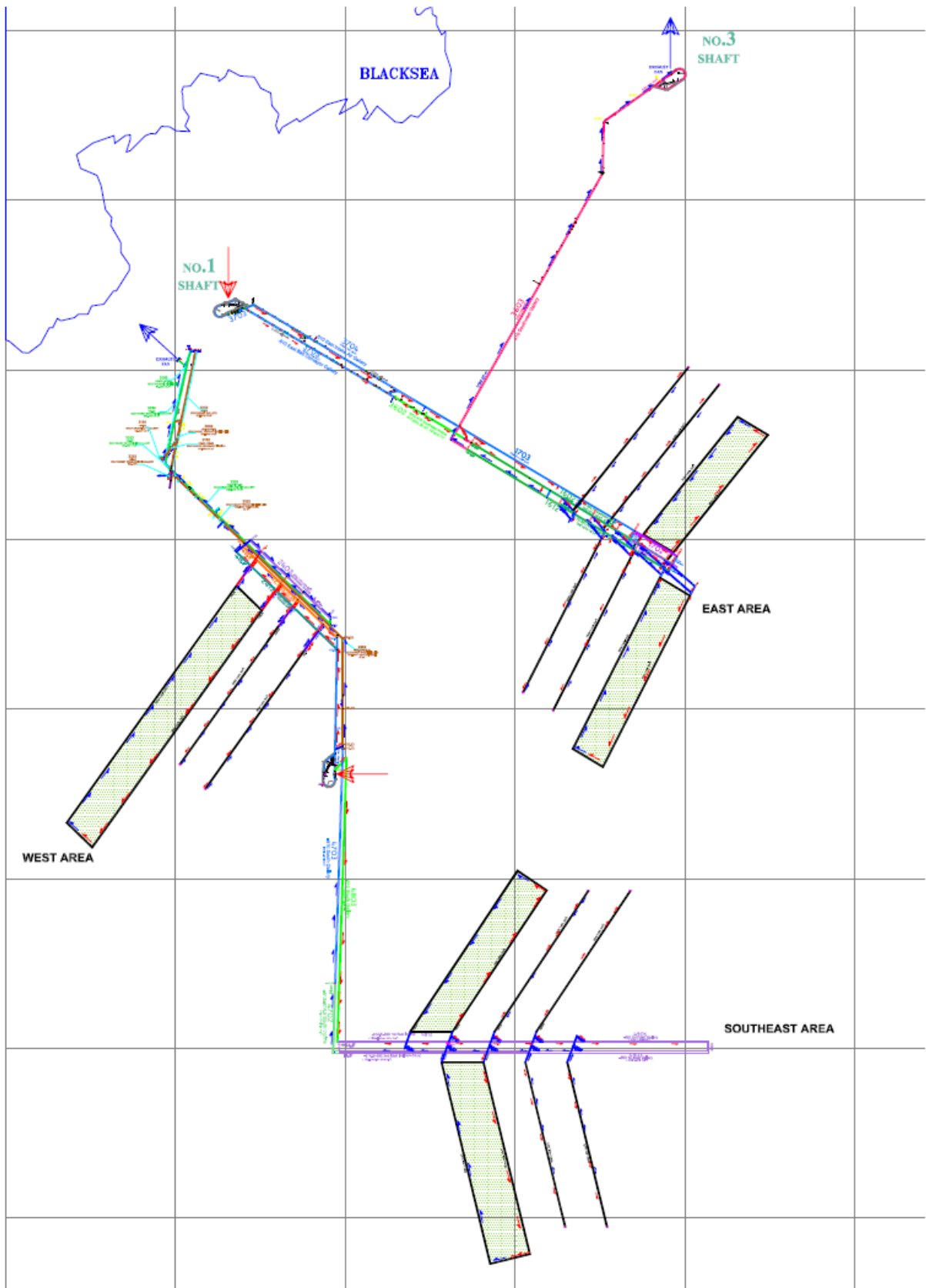

Figure 46. Ventilation Plan

4.4. METHANE DRAINAGE METHODS TO BE APPLIED

35% of methane is being planned to be drained with four drainage methods in three phases during development, production and after production.

METHANE DRAINAGE METHOD:1

Intake air and return air cross cut galleries of panels, whose production has finished, are sealed with concrete dams. Stratified sandstone at roof and floor of the panels where production has ended is being considered as “gas-carrier”. Both gas within sandstone and within coal seams at 160m upper and 60m lower of the production seam will accrue at gobs. This gas will be drained by gas pipes located behind the concrete dam (Figure 47).

METHANE DRAINAGE METHOD:2

During development works, gas drainage boreholes will be drilled towards surrounding seams of the gallery (Figure 47).

METHANE DRAINAGE METHOD:3

Drainage holes will be drilled parallel to inclination with 50m intervals towards coal seam.

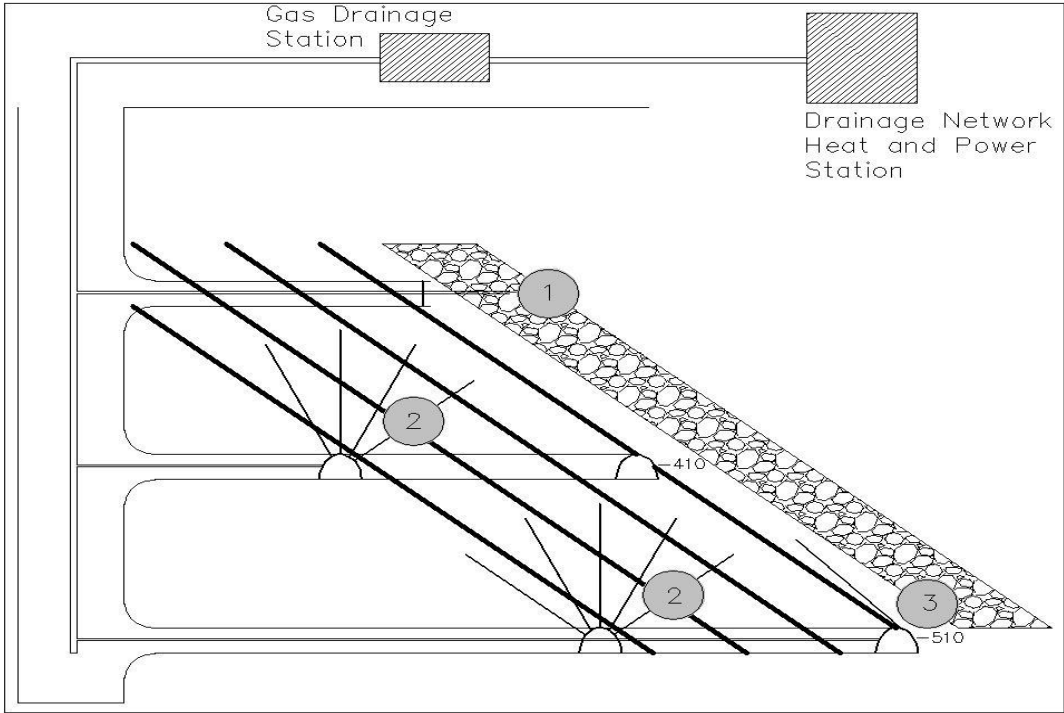

Figure 47. Methane Drainage Methods To Be Applied

METHANE DRAINAGE METHOD:4

During production, drainage holes will be drilled 20m ahead of the face towards the gob side at the main gate (Figure 48, Figure 49, Figure 50). Drainage holes will be 50° inclined towards to face and gob side. The point is to make drainage holes reach areas where pressure and fractures are intensive.

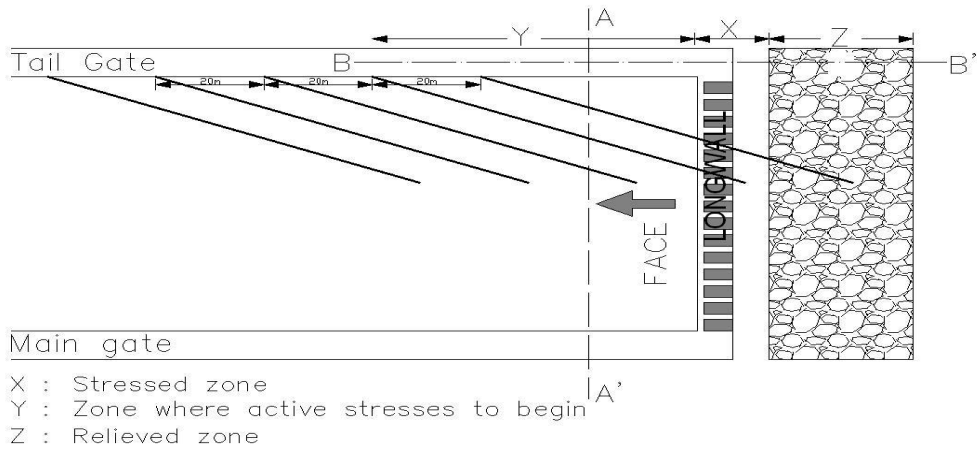

Figure 48. Plan View of Drainage Method:4

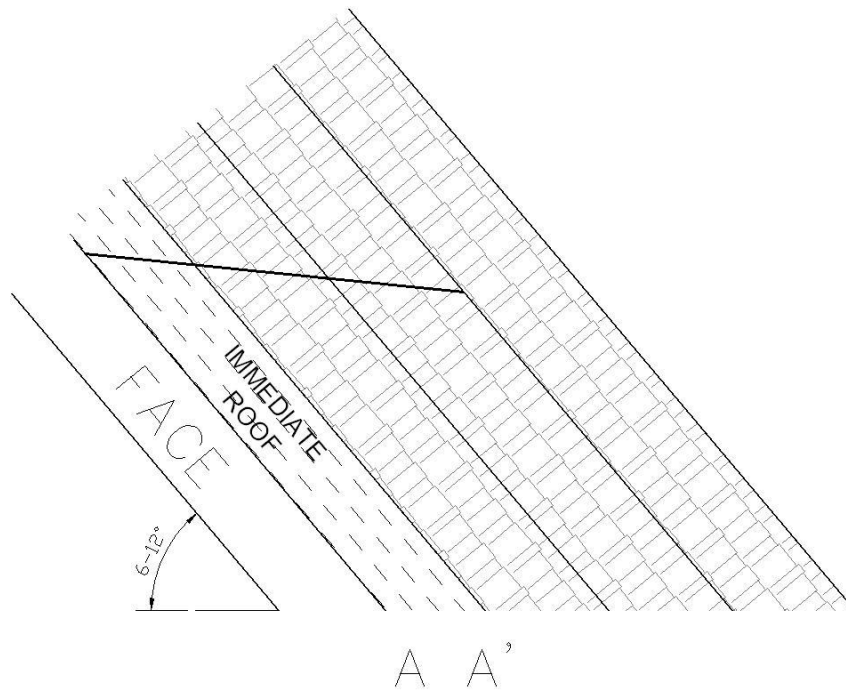

Figure 49. Cross Section of Method:4 Parallel to Face Direction

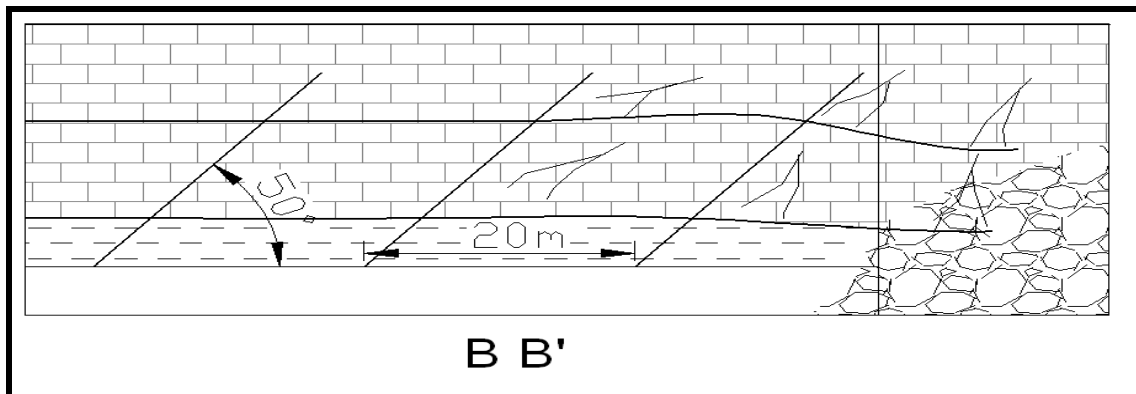

Figure 50. Cross Section of Method:4 Vertical to Face Direction

HEMA has been contacted with several companies up to now and decided to cooperate with GREEN GAS (from Czech Republic) in order to utilise mentioned gas drainage studies. In consequence of meetings and discussions realised for Amasra-B Hardcoal Project HEMA has received a proposal to execute gas drainage project for Amasra-B.

As a first stage of this proposal; Green Gas will make existing gas drainage station functional and drill at intersected coal seams which are in main roadways developments in Shaft 1. Regarding to these works gas drainage station and its related pieces such as vacuum pumps, control panels, equipments etc. and underground drilling rigs will be examined and expertised by Green Gas.

These intersected coal seams are the same as coal seams to be produced, which are designed for production panels on, in eastern Block. This operational work mentioned above will give information about execution of gas drainage borehole planning in panel developments according to test results. In conclusion it is anticipated that 35% gas of mine will be reduced by this gas drainage system.

When planning, implementing and managing this methane drainage system, the following factors will be taken into account:

- Safety of access for drilling, monitoring and regulation.
- Ground stability and necessary support systems to stabilize boreholes.
- Gas drainage borehole configurations with consideration given to differences between the expected performance of roof and floor post-drainage boreholes.
- Drainage capacity, pipe diameters, extraction pump and infrastructure requirements.
- Location, installation and commissioning of the drainage pipe network.
- Water traps and dewatering facilities.
- Operational control and maintenance of the drainage system and infrastructure.
- Monitoring of boreholes, pipe Networks and the surface extraction plant.
- Protection of gas drainage pipes from crushing behind longwall retreat faces.

5. MAIN HAULAGE SYSTEMS

5.1. COAL AND WASTE ROCK HAULAGE

5.1.1. EAST PRODUCTION BLOCK COAL HAULAGE ROADS AND EQUIPMENT

In East Block, coal coming from stage-loader located in main gate will be transported with 1200mm-wide max.2200 meter length belts to the cross cut conveyor. Working speed will be 2m/s and capacity will be 2000ton/h. Belt will be selected to have strength of 1300 N/mm. All drums of the belt conveyor system will be rubber-finish and belt will be roof suspended.

Tension and storage units will be available in belt conveyor systems. Coal cut at the face will be loaded to belt conveyor (located in gateway) from stage-loader and then conveyed to the silos at bottom of Shaft No.1.

5.1.2. WEST PRODUCTION BLOCK COAL HAULAGE ROADS AND EQUIPMENT

In West Block, coal coming from stage-loader located in maingate will be transported with 1200mm-wide and 2200m-long belt to the cross cut conveyor. Working speed will be 2m/s and capacity will be 2000ton/h. Belt will be selected to have strength of 1300 N/mm. All drums of the belt conveyor system will be rubber-finish and belt will be roof suspended

Tension and storage units will be available in belt conveyor systems. Coal cut at the face will be loaded to belt conveyor (located in gateway) from stage-loader and then conveyed to No.2412, 2703, 2502, 2202 gallery to be hauled to surface.

5.1.3. SOUTHEAST PRODUCTION BLOCK COAL HAULAGE ROADS AND EQUIPMENT

In Southeast Block, coal coming from stage-loader will be transported with 1200mm-wide and 2200m-long belt conveyors, which will be transferred from East Block mechanized panels, to the cross cut conveyor.

Tension and storage units will be available in belt conveyor systems. Coal cut at the face will be loaded to belt conveyor (located in gateway) from stage-loader and then conveyed to belt conveyor in West Block.

5.2. MATERIAL AND MEN TRANSPORTATION

5.2.1. MEN AND MATERIAL TRANSPORTATION OF EAST PRODUCTION BLOCK

Personnel and materials will be transported with the cage system in Shaft No.1 from surface (+86,50m) to -510 level. After that point bottom-railed battery-locomotives will be used horizontal roadways (%0,3 inclinations).

In the inclined galleries, roof-suspended monorail system will be used for between -500,46 and -419,47 levels and between 500,46 and 529,25 with 5° inclination. For this system, diesel monorail will be used.

Face equipment will be transported with monoroil to the gateways and with hydraulic winches in the face.

5.2.2. MEN AND MATERIAL TRANSPORTATION OF WEST PRODUCTION BLOCK

Personnel and materials will be transported with the cage system in Shaft No.2 from surface to -510 level. After that point bottom-railed battery-locomotives will be used horizontal roadways (800m).

Roof-suspended monorail system will be used for transportation in inclined galleries. For this system, diesel monorail will be used.

Face equipment will be transported with monorail to the gateways and with hydraulic winches in the face.

5.2.3. MEN AND MATERIAL TRANSPORTATION OF SOUTHEAST PRODUCTION BLOCK

Personnel and materials will be transported with the cage system in Shaft No.2 from surface to -610 level. After that point bottom-railed battery-locomotives will be in horizontal roadways (1675m).

In the inclined galleries, roof-suspended monorail system will be used for transportation. For this system, diesel monorail will be used. System will be transferred from East Block after the production activity is completed there.

Face equipment will be transported with monorail to the gateways and with hydraulic winches in the face.

5.3. TRANSPORTATION PLAN

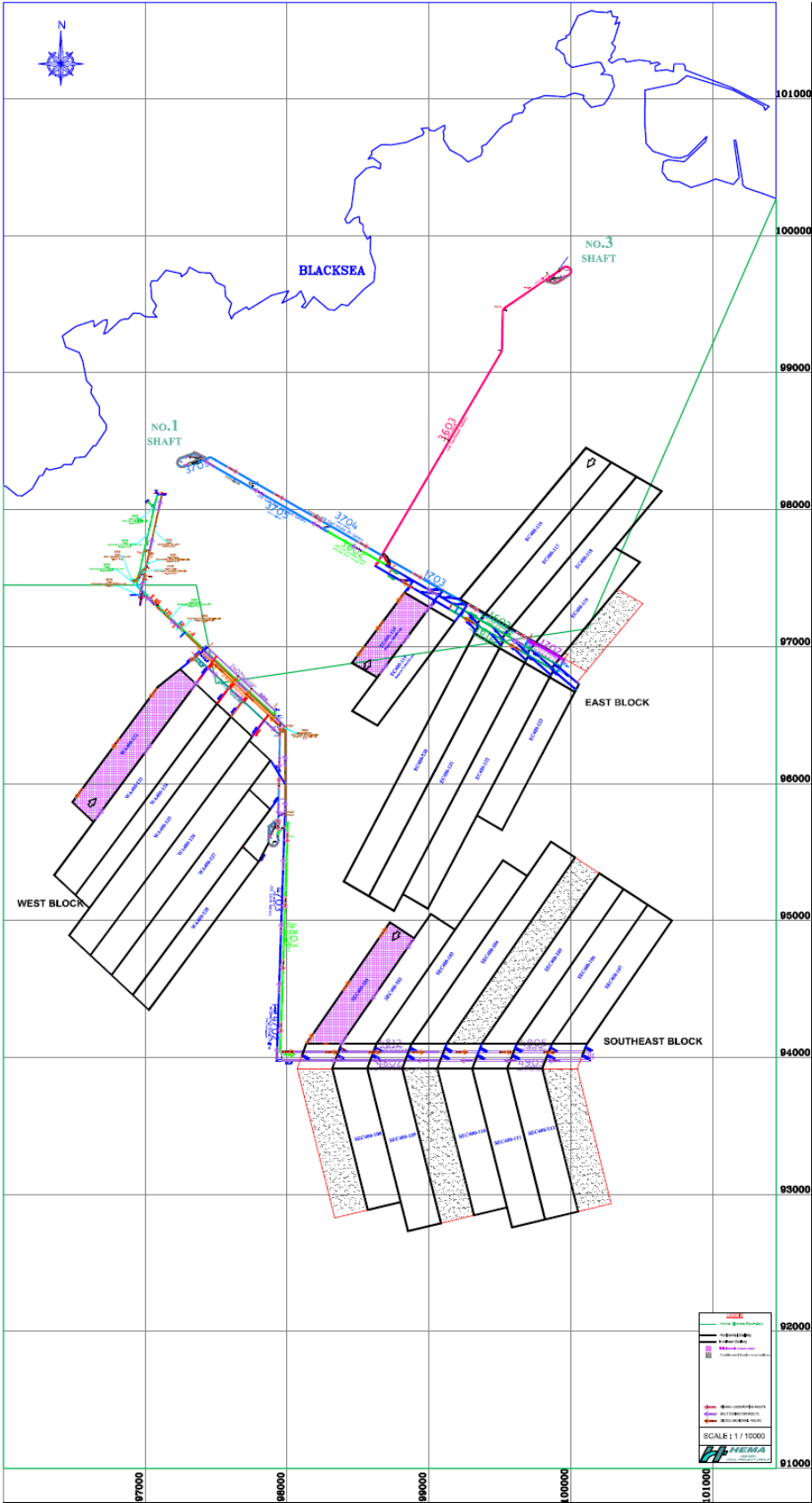

Figure 51. Production, Personnel and Material Transportation Plan

Transportation plan is also attached as Appendix-33.

6. OTHER FACILITIES IN UNDERGROUND

6.1. COMPRESSED AIR, HYDRAULIC AND WATER LINES

6.1.1. COMPRESSED AIR FACILITIES

For East and West Block, during development works Shaft No.3 will have 3 pcs. 21 m³/min SA 120 A type, 1 pcs. 40,5 m³/min SA 250 A type compressor installed at compressor room.

Shaft No.2 will have 1 pcs. 21 m³/min SA 120 A type, 1 pcs. 40,5 m³/min SA 250 A type and 1 pcs. 43 m³/min LGFD-43/8-X type compressor installed at compressor room.

Shaft No.1 will have 1 pcs. 21 m³/min SA 120 A type, 1 pcs. 40,5 m³/min SA 250 A and 1 pcs. 43 m³/min LGFD-43/8-X type compressor installed at compressor room.

6.1.2. HYDRAULIC PUMP STATIONS

6.1.2.1. EAST PRODUCTION BLOCK HYDRAULIC PUMP STATION

In East Block, the high pressurized fluid required by the power supports and hydraulic props will be supplied by the 4 hydraulic pumps to be installed in East Block. Each pump has 70-90kw, 115 litre/min and max 350bar capacity. Synthetic boron oil will be used at 1% to prevent corrosion. Hydraulic pump locations and drawing details are available on site if requested.

6.1.2.2. WEST PRODUCTION BLOCK HYDRAULIC PUMP STATION

In West Block, the high pressurized fluid required by the power supports and hydraulic props will be supplied by the 4 hydraulic pumps to be installed in West Block. Each pump has 70-90kw, 115 litre/min and max 350bar capacity. Synthetic boron oil will be used at 1% to prevent corrosion. Hydraulic pump locations and drawing details are available on site if requested

6.1.2.3. SOUTHEAST PRODUCTION BLOCK HYDRAULIC PUMP STATION

In Southeast Block, the high pressurized fluid required by the power supports and hydraulic props will be transferred from East Block. Hydraulic pump locations and drawing details are available on site if requested

6.2. WATER DRAINAGE

6.2.1. EFFECT OF GROUND WATER TO THE PRODUCTION IN THE FIELD

Santonien-Kaniosien aged andesite, located upper levels of formation, with cracks is the aquifer unit of field. There are no permeable units below and above aquifer. Field's water income is from where andesite is outcropped and from meteoric waters.

Since there are no permeable units above coal bearing very thick Carboniferous aged units, no water income from surface occurs. Hydrogeology report done for Kazpınar region and for entire Amasra Hardcoal Basin is given as Appendix-50A and Appendix-50B. The results stated in the report for Kazpınar region is as follows:

As a result of pumping test using the observation well for drawdown measurements that is 92m away from the pumping well, the transmissivity and storage coefficient of the confined aquifer (Upper Cretaceous – Santonian Andesite – Agglomerate) are found to be $T= 2.15 \text{ m}^2/\text{day}$ and $S=1.4 \cdot 10^{-5}$, respectively.

By pumping with the rate of $200 \text{ m}^3/\text{day}$, which is the capacity of the pump in the pumping well, which is 530 m away from the pumping well, will be affected in 20 hours after the pumping started.

The pumping well should stop pumping 20 h long before another pumping activity.

The optimum management of the pumping is to operate the well 12h (for instance from 08.00 am to 08.00 pm), and stop pumping 12 h long at the rest of the day.

In addition to these report, no water problem has been reported about Amasra and Zonguldak where coal is being producing for many years. For instance, production operation in Kozlu district is being held at sub-sea level for over 40 years.

Coal is being producing in Amasra basin since 1968. No water problem during production operations has been reported, yet. -350 is the current and the most deepest production level of TTK is in the south of Tuna Fault. Drained water records were taken from TTK Amasra.

According to TTK records, mine has 2 main water sumps at -100 and -250. Maximum 200 ton/day water is pumped to water treatment facility located at +24 from -100 sump which is also feed by -250 sump. Purified water stored at tank that has 400 ton capacity. Due to mine needs, 150 ton water is used at surface and 50 ton is used underground. As seen on TTK records, daily water income is around 150 m^3 which can be considered as very low.

In the project, each shaft bottom station has 600 m^3 capacity water sumps. In case water income may increase, sump plans are compatible with a parallel second water sump (Appendix-28, Appendix-29, Appendix-30 and Appendix-31).

Two pieces model SKM 65/10 water pumps, that have 132 kW engine power and 1100 V voltage, has been purchased for -410 water sump of Shaft No.3. These pumps are capable of draining water up to 500 meters with $50 \text{ m}^3/\text{h}$ flow rate and they will pump water for 442m up to surface.

Two pieces model SKM 65/11 water pumps, that have 132 kW engine power and 1100 V voltage, has been purchased for -510 water sump of Shaft No.1. These pumps are capable of draining water up to 640 meters with 20 m³/h flow rate and will pump water for 596m up to surface.

In case Hema Hardcoal Mine will have the same water income figures with TTK mine which is still active, planning has been prepared capable of draining water in 10 hours with 1 pump, in 5 hours with 2 pumps at Shaft No.1 and in 4 hours with 1 pump, in 2 hours with 2 pumps at Shaft No.3.

In Shaft No.2, water drainage will be in two stage. Firstly, water will be sent to -250 water sump from -510 water pump. Then water will be sent to surface. Water pumps, which will work at -410 and -510 sumps of Shaft No.2, will be 4 pieces, each with 250 kW engine power, 1100 V voltage and 100 m³/h flow rate.

In production areas, 6 pieces of SKM 65/10 model (132 kW engine power, 1100 V voltage) water pumps, that are capable of working horizontal and inclined until 14° dip, will be purchased.

6.3. CONTROL-COMMAND CENTER

Entire equipment and machinery working for mine will be integrated to an automation system. Communication between related surface facility and underground will be done via an underground telephone system. Entire equipment underground and on surface will be monitored with a monitoring system installed in command center. Gas status (CO, CH₄, CO₂, O₂, H₂S) and ventilation status of mine will also be monitored and recorded with monitoring system in command center.

Planned control and communication network diagram is given in Figure 52 below:

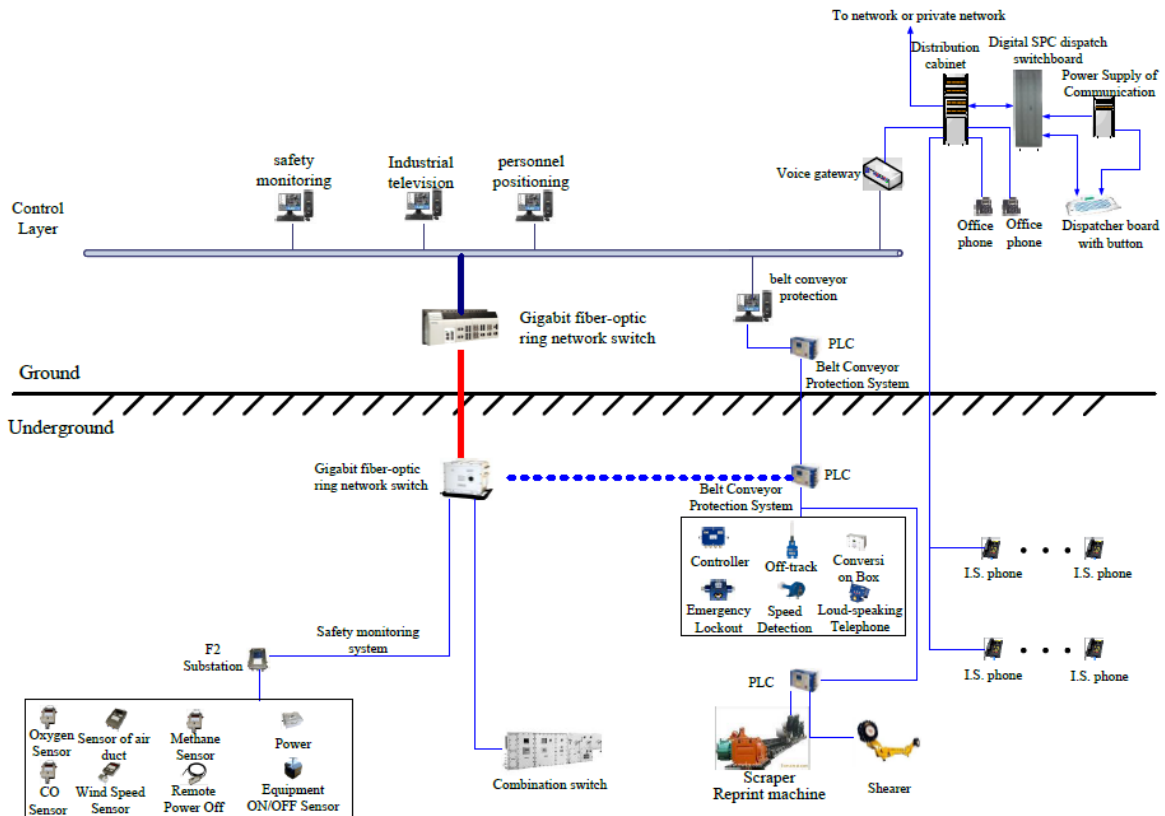

Figure 52. Control, Communication and Monitoring System

The main technical features of the system is as follows:

- System has acquisition, display and alarm functions of gas, wind, carbon monoxide, temperature and other analog values and feed status, fan ON/OFF, air duct status, air door ON/OFF, smoke and other switching values;
- System has the sensor fault alarm, local or remote power switch off, methane interlock functions;
- System has the monitor and display functions of gas drainage;
- In a variety of display modes, system software has a main menu display which includes parameter setting, page editing, control, list shows, the curve shows, a state diagram and histogram display, simulation diagram display, print, inquiry, help, etc
- System software has the display function of analog data tables, real time analog data, analog curve, switch state tables, switch state diagram and histogram;
- System software has simulation diagram display function of ventilation system, gas drainage system, self-test of monitoring system;
- System software has the function of sound and light alarm and text message transmission;
- System software has the function of statistics records, alarm and power-off records of analog and switching values;
- System, flexible network, can transmit either through the transmission interface with cable, or directly through the switch with optical fiber.

7. COAL WASHING PLANT, COAL PREPERATION AND MARKETING

7.1. COAL WASHING PLANT

Coal washability studies were held by accredited university laboratories. The summarized report of washability studeies is given as Appendix-39.A. It is planned to build a 2x500 tph capacity washing plant facilities for the Amasra Mine based on coal chemical analysis given in Table 2, Table 3, Table 4. The equipment list of planned facility is given as Appendix-39.B. Coals from East and West Blocks will be handled in separate lines. Shallow coals will be handled in a separate facility which is situated close to the mouth of inclined gallery. Shallow coals will be handled in this separate facility until 2018. The market in 2018 will determine whether the shallow coal facility will be still be required.

For Westphalian A (WA-West Block Coal) and Westphalian C (WC-East Block Coal) coal; there will be drum separator units for 10-18mm, 18-100mm material and cyclone module units for +0,5-10mm material. -0.5mm material will be process in spiral. Detailed washing flow sheet is given in Appendix-39.C.

Total R.O.M. and washed coal production distribution is given as Table 38. Screen analysis of both R.O.M. and washed coals of WA and WC are also given as Table 39, Table 40, Table 41 and Table 42.

The anticipated ROM feed qualities and other parameters are provided in Appendix-36.B. the basis and source of the information used to determine the wash plant feed includes:

- Size range has been determined from experienced and other mining operations using similar mining technology (Soma, Çayırhan, Tunçbilek).
- Additional samples have been gathered from Amasra-A and Amasra-B operations.
- Quality has been determined from borehole data and anticipated panel by panel extraction (Appendix-14).
- It is anticipated that the shearer operations will create more fines than operations utilising the plough. HEMA have requested information from potential plough suppliers to confirm this expectation.

HEMA believes that they have the opportunity and sufficient time to tailor the wash plant for the potential coking coal over the next three years.

The semi mechanized operations in West Block Shallow Coals will supply ROM to 200tph plant. The design of this plant has been based on the experienced gained from the Kandilli Operations. Details of the plant can be seen in Appendix-40.B.

ROM feed qualities for Shallow Coal operations are provided in Appendix-36.B. The coals are of different quality to those mined in Kandilli and the wash plant has been designed accordingly. Channel samples have been taken from the seams that have been intersected during the development. HEMA have sent these samples to Bülent Ecevit University to undertake washing tests and proximate analysis. The results have been used for wash plant design and market evaluation.

All products from Shallow Coals will be loaded to trucks to be sent to potential markets.

7.2. POTENTIAL MARKET IN TURKEY

Hardcoal consumption in Turkey is heavily dependent on imported coal. As per TTK's 2012 Hardcoal Sector Report (available in Turkish at http://www.enerji.gov.tr/yayinlar_raporlar/Sektor_Raporu_TTK_2012.pdf), in 2012 hardcoal consumption in Turkey increased to 26,2 million tons from 25,6 million tons of consumption in 2011 whereas domestic production in 2012 fell to 2,3 million tons from 2,6 million tons in 2011.

In 2011 10,1m tons of hardcoal has been consumed by thermal power plants, 1,5 million tons by steel plants, 2,3 million tons by cement plants and 6,8 million ton by households for heating. Currently Ereğli (approximately 120km from Amasra) imports 4 million ton per year (coking and PCI). Eren power plant (approximately 90km from Amasra) imports 3,5 million ton per year. This power plant has plans to double in size over the next 4 years.

The saleable products of Amasra Hardcoal Project falls within a spectrum of Westphalian A and Westphalian C coals of varying sizes. Such products has a diversified and robust target markets such as thermal power plants, households (for heating purposes), steel plants, cement plants, lime plants etc.

Amasra Hardcoal Project will be in a position to ship 18 - 100mm and 10 - 18mm coals as heating coal to local market (households). The heating coal market in the direct vicinity of Amasra Hardcoal Project is 300k tons/year and entire Turkish market is 6 - 7 million tons/year. Hence the revenue stream shall be enhanced given that heating coal has more than 100% premium when compared to steam coal.

Likewise some portion of Westphalian A coals would be eligible to be sold to cement and steel plants at higher prices. Some of the target purchasers of such coals are Bolu Cement Plant, Bartın Cement Plant, Bartın Lime Plant, Bursa Cement Plant, Erdemir and Kardemir Steel Plants.

In order to be conservative Amasra Hardcoal Project, however, assumes that all of the hardcoal produced shall be sold to thermal power plants (regional market: Eren Power Plant, Çatalağzı Power Plant) as steam coal. In consequence, sales prices could be updated upon completion of transportation and market study.

The determination of the potential outputs from Amasra are presented in Appendix-36.B. HEMA have anticipated selling prices that reflects the current situation in Turkey. HEMA believe (after discussions with potential users) that they have a ready market for coals from East Block. The price for East Block coals have been estimated at €72,65/t.

From the ongoing geological investigations HEMA have had samples from the West Block mining area analysed (Erdemir, NormLab, Kardemir, AGLab, StandartLab) and believe there is a potential that some of the coals are suitable for sale as coking coals. HEMA can provide the copies of the these analysis if requested. On this basis HEMA have projected the potential for improvement to coal selling prices (West Block coals) from 2017 from 72,65€/t to 151,25€/t. Initial production estimates project that about 500.000 tons per year of clean coal with the potential to be sold as coking coal. The fine coal from the West Block initial production starting at around 300.000 tons per year.

HEMA have agreement with a potential buyer to test 250 kg of the West Block coals as a precursor to entering a coking coal supplying contract. This sample is scheduled for extraction.

Table 38. RoM and Washed Coal Production Distribution

YEARS	PRODUCED WC COALS (ton)	WASHED WC COALS		PRODUCED WA COALS (ton)	WASHED WA COALS				TOTAL WC PRODUCT (ton)	TOTAL WA PRODUCT (ton)	TOTAL PRODUCT (ton)	TOTAL DISCARD (ton)	GRAND TOTAL (ton)
		0 - 10 mm (ton)	Discard (ton)		18-100 mm (ton)	18-10 mm (ton)	0 - 10 mm (ton)	Discard (ton)					
2014	17.538	12.774	4.764	-	-	-	-	-	12.774	-	12.774	4.764	17.538
2015	747.325	544.338	202.987	-	-	-	-	-	544.338	-	544.338	202.987	747.325
2016	2.212.638	1.611.645	600.993	-	-	-	-	-	1.611.645	-	1.611.645	600.993	2.212.638
2017	2.083.376	1.517.493	565.883	682.977	114.642	70.065	329.304	168.966	1.517.493	514.011	2.031.504	734.849	2.766.353
2018	1.969.956	1.434.880	535.076	975.409	163.728	100.065	470.303	241.312	1.434.880	734.097	2.168.977	776.388	2.945.365
2019	3.481.863	2.536.126	945.737	1.133.133	190.203	116.246	546.351	280.333	2.536.126	852.800	3.388.926	1.226.070	4.614.996
2020	2.011.870	1.465.409	546.461	2.389.617	401.112	245.146	1.152.178	591.182	1.465.409	1.798.435	3.263.845	1.137.642	4.401.487
2021	2.122.765	1.546.183	576.582	3.020.290	506.974	309.846	1.456.263	747.208	1.546.183	2.273.082	3.819.266	1.323.789	5.143.055
2022	1.615.346	1.176.589	438.757	3.025.048	507.772	310.334	1.458.557	748.385	1.176.589	2.276.663	3.453.252	1.187.142	4.640.394
2023	1.789.314	1.303.304	486.010	2.905.590	487.721	298.079	1.400.959	718.831	1.303.304	2.186.759	3.490.062	1.204.842	4.694.904
2024	1.821.666	1.326.868	494.798	3.026.678	508.046	310.501	1.459.343	748.788	1.326.868	2.277.890	3.604.758	1.243.586	4.848.344
2025	1.893.329	1.379.066	514.263	2.507.776	420.945	257.268	1.209.149	620.414	1.379.066	1.887.362	3.266.429	1.134.676	4.401.105
2026	1.948.357	1.419.148	529.209	2.069.262	347.338	212.281	997.715	511.927	1.419.148	1.557.335	2.976.483	1.041.136	4.017.619
2027	2.029.465	1.478.225	551.240	2.139.900	359.195	219.528	1.031.774	529.403	1.478.225	1.610.497	3.088.723	1.080.642	4.169.365
2028	3.212.775	2.340.127	872.648	1.773.700	297.726	181.960	855.207	438.806	2.340.127	1.334.894	3.675.020	1.311.455	4.986.475
2029	3.694.857	2.691.266	1.003.591	1.316.283	220.946	135.035	634.659	325.643	2.691.266	990.640	3.681.906	1.329.234	5.011.140
2030	3.913.311	2.850.384	1.062.927	1.156.347	194.100	118.627	557.544	286.076	2.850.384	870.271	3.720.656	1.349.002	5.069.658
2031	3.603.907	2.625.020	978.887	1.137.315	190.905	116.675	548.368	281.367	2.625.020	855.948	3.480.968	1.260.254	4.741.222
2032	3.757.593	2.736.962	1.020.631	1.143.589	191.958	117.319	551.393	282.919	2.736.962	860.670	3.597.632	1.303.550	4.901.182
2033	3.444.084	2.508.608	935.476	1.172.165	196.755	120.250	565.171	289.989	2.508.608	882.176	3.390.784	1.225.465	4.616.249
2034	4.798.008	3.494.782	1.303.226	969.898	162.803	99.500	467.646	239.949	3.494.782	729.949	4.224.731	1.543.175	5.767.906
2035	4.143.998	3.018.413	1.125.585	1.112.547	186.748	114.134	536.426	275.240	3.018.413	837.307	3.855.720	1.400.825	5.256.545
2036	1.343.213	978.372	364.841	1.129.418	189.580	115.865	544.560	279.413	978.372	850.005	1.828.376	644.255	2.472.631
2037	1.226.286	893.204	333.082	1.038.123	174.255	106.499	500.541	256.827	893.204	781.296	1.674.500	589.909	2.264.409
2038	1.197.466	872.212	325.254	1.123.463	188.580	115.254	541.689	277.940	872.212	845.523	1.717.735	603.194	2.320.929
2039	1.138.252	829.082	309.170	1.081.500	181.536	110.949	521.456	267.559	829.082	813.941	1.643.023	576.729	2.219.752
2040	1.226.670	893.484	333.186	602.321	101.103	61.791	290.415	149.012	893.484	453.309	1.346.793	482.198	1.828.991
2041	2.159.150	1.572.685	586.465	-	-	-	-	-	1.572.685	-	1.572.685	586.465	2.159.150
2042	2.182.733	1.589.863	592.870	-	-	-	-	-	1.589.863	-	1.589.863	592.870	2.182.733
2043	1.720.273	1.253.015	467.258	-	-	-	-	-	1.253.015	-	1.253.015	467.258	1.720.273
TOPLAM	68.507.384	49.899.530	18.607.854	38.632.349	6.484.672	3.963.215	18.626.973	9.557.489	49.899.530	29.074.860	78.974.390	28.165.343	107.139.733

Table 39. Screen Analysis of Westphalian-C Coal

SCREEN ANALYSIS OF WESTPHALIAN-C COALS			
Grain Size (mm)	Weight (%)	Ash (%)	Content (%)
18-100	48,10	43,09	2072,63
10-18	14,70	30,80	452,76
0,5-10	27,93	22,10	617,25
-0,5	9,27	21,70	201,16
TOTAL	100,00	33,44	3343,80

Table 40. Screen Analysis of Westphalian-A Coal

SCREEN ANALYSIS OF WESTPHALIAN-A COALS			
Grain Size (mm)	Weight (%)	Ash (%)	Content (%)
18-100	32,28	28,48	919,33
10-18	12,36	25,07	309,87
0,5-10	44,65	21,33	952,38
-0,5	10,71	30,90	330,94
TOTAL	100	25,13	2512,52

Table 41. Clean Coal Screen Analysis of Westphalian-C Coal

PRODUCT (WC COALS)	Weight (%)	Ash (%)		Moisture (%)
18-100 mm	29,60	22,84	6000 ± 200 kcal/kg	6
10-18 mm	11,04	16,60	6000 ± 200 kcal/kg	6
0,5-10mm	22,93	11,08	5800 ± 200 kcal/kg	12
-0,5 mm	9,27	21,70	5800 ± 200 kcal/kg	14
Product Total	72,84	18,05	6000 ± 200 kcal/kg	10
Discard	27,16	74,71		
GRAND TOTAL	100,00			

Table 42. Clean Coal Screen Analysis of Westphalian-A Coal

PRODUCTS (WA COALS)	Weight (%)	Ash (%)		Moisture (%)
18-100 mm	16,79	10,64	4800 ± 200 kcal/kg	8
10-18 mm	10,26	12,55	5600 ± 200 kcal/kg	8
0,5-10mm	37,51	12,10	6800 ± 200 kcal/kg	10
-0,5 mm	10,71	39,90	6800 ± 200 kcal/kg	11
Total	48,22	18,28	6000 ± 200 kcal/kg	9
Discard	24,74	53,52		
GRAND TOTAL	72,96			

7.3. STOCK YARD, SILOS AND TRANSPORTATION UNITS

7.3.1. TRANSPORTATION VIA HIGHWAY

The possibility to transport the coal from land until the port is constructed is being considered. Current access roads and planned road (under constructions) and new tunnel will allow coal transportation. Available access roads, planned access road and tunnel construction layout is given as Appendix-10.A. The cross section of new tunnel road is given as Appendix-10.B. New tunnel, that has been built by State Highways, is going to be available for use at the end of 2013. The axle load for new tunnel is 60 ton.

The application for new road construction is given as Appendix-10.C and Appendix-10.D. A detailed study for transportation (in Turkish) capacity is attached as Appendix-10.E.

HEMA have a plan for a truck loading facility at the wash plant. This facility has sufficient space to allow the loading of 8 trucks per hour. HEMA have made provision for the possibility of parking 25 (40 ton) trucks adjacent to the wash plant.

8. AUXILIARY SURFACE FACILITIES PROJECT AND PLANNING

8.1. ELECTRIC ENERGY SUPPLY AND TOTAL POWER

Yearly energy requirement of facilities of coal production is given in Table 43. Powers of all machinery is given in Appendix-41.A. Power schemes, line diagrams of underground equipment and mine system are given as Appendix-41B.-41.I.

Table 43. Energy Demand by Years

ENERGY DEMAND OF HEMA BY YEARS												
YEARS	SHAFT 1			SHAFT 2			SHAFT 3			SHAFTS TOTAL	POWER PLANT DEMAND	TOTAL ENERGY DEMAND
	SURFACE FACILITIES	UNDERGROUND FACILITIES	Σ	SURFACE FACILITIES	UNDERGROUND FACILITIES	Σ	SURFACE FACILITIES	UNDERGROUND FACILITIES	Σ			
2011-2012	1	1	2	1	0	1	1	1	2	5	0	5
2012-2013	1	2	3	1	3	4	1	2	3	10	0	10
2013-2014	10	2	12	1	1	2	3	2	5	19	2	21
2014-2015*	12	8	20	2	9	11	3	1	4	35	3	38
2015-2016	12	8	20	5	9	14	3	1	4	38	10	48
2016-2017	12	8	20	5	9	14	3	1	4	38	15	53
2017-2018	12	8	20	5	9	14	3	1	4	38	30	68
2018-2019	12	8	20	5	9	14	3	1	4	38	40	78
2019-2020	12	8	20	6	9	15	3	1	4	39	50	89

8.1.1. TRANSMISSION LINE

2x1272MCM transmission line from TEİAŞ 154 kV to Kazpınar Shaft No.2 will be installed according to energy demand (Figure 53). 154/31.5 kV, 2x25 MVA transformers will feed current 31,5 kV switching stations. All shafts energy will be fed from Kazpınar Shaft No.2 substation after the integration of switching stations of Shaft No.1 and No.3 with 31,5 kV transmission (Figure 54).

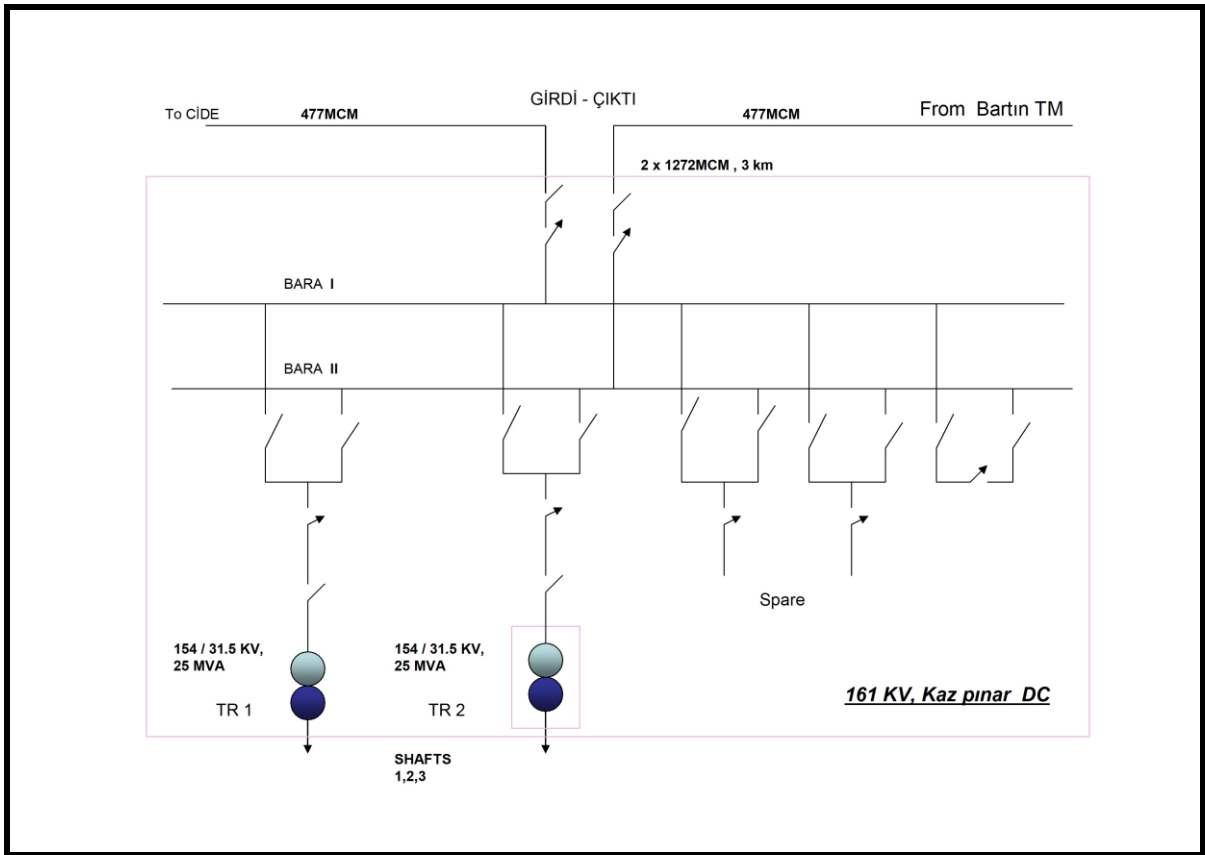

Figure 53. 2x1272MCM Transmission Line from 154 kV of TEİAŞ to Kazpınar DC

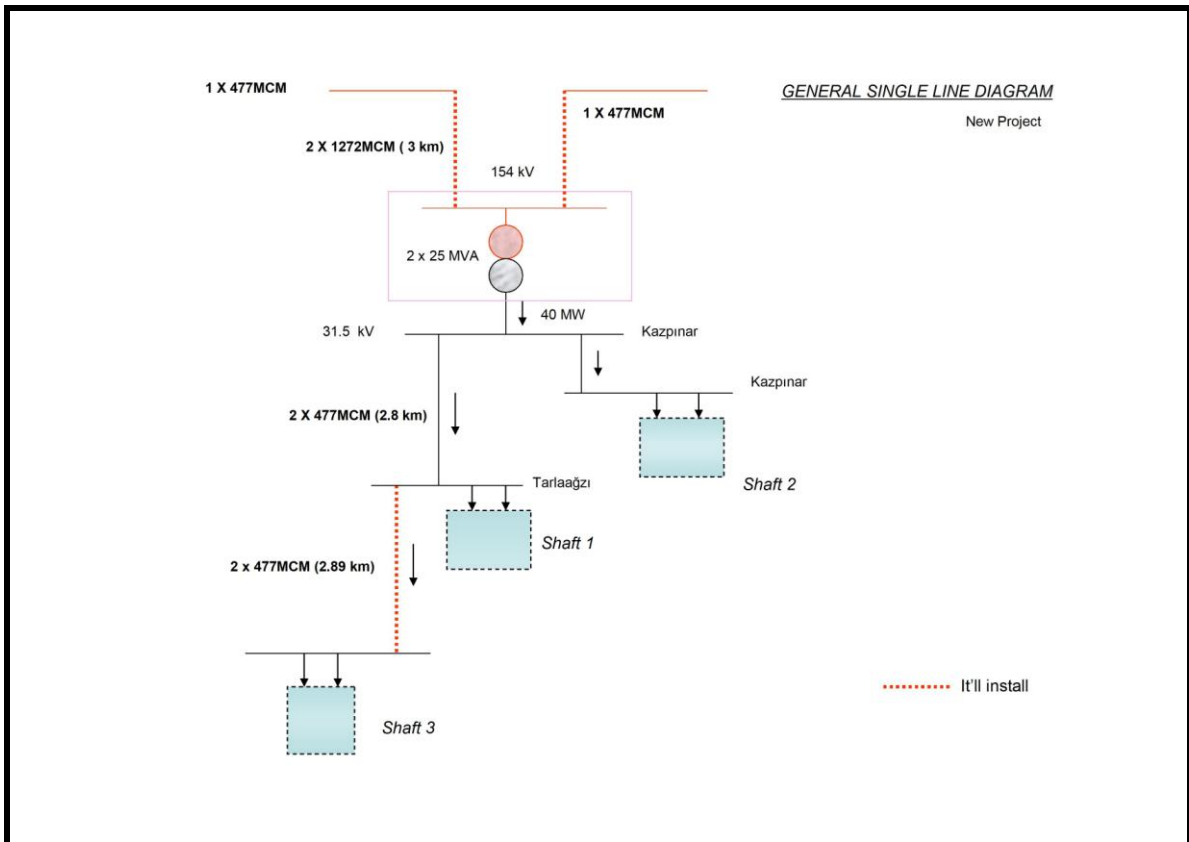

Figure 54. Connection of 31,5 kV Shaft Switchgears to 31,5 kV Transmission Line

8.1.2. MAIN SUBSTATIONS

Power demand of all shafts are currently met by their 31,5 kV switch and substations. Current facilities are compatible with possible new transformer integration. Thus, final transformer and switching stations will be installed over current facilities.

Transmission lines (154 kV and 31,5 kV) which will be installed are capable for power demand of all facilities. Tarlağzı-Amasra 31,5 kV transmission line will be completed within this year and works for 154 kV transmission line and transformer/switching stations will be held with TEİAŞ.

Transformer, cable and switching equipment for surface facilities will be provided by domestic suppliers and for underground by overseas suppliers.

Ventilation equipment has been brought to our facilities. Electrical equipment supply and installation studies of winders are still ongoing. Overseas procurement of underground substations is still in process.

8.1.3. SINGLE LINE POWER FLOW CHART

Power requirement of each shaft surface and underground facilities and their transformer, switching stations flow charts are given in Figure 55, Figure 56, Figure 57, Figure 58, Figure 59 and Figure 60.

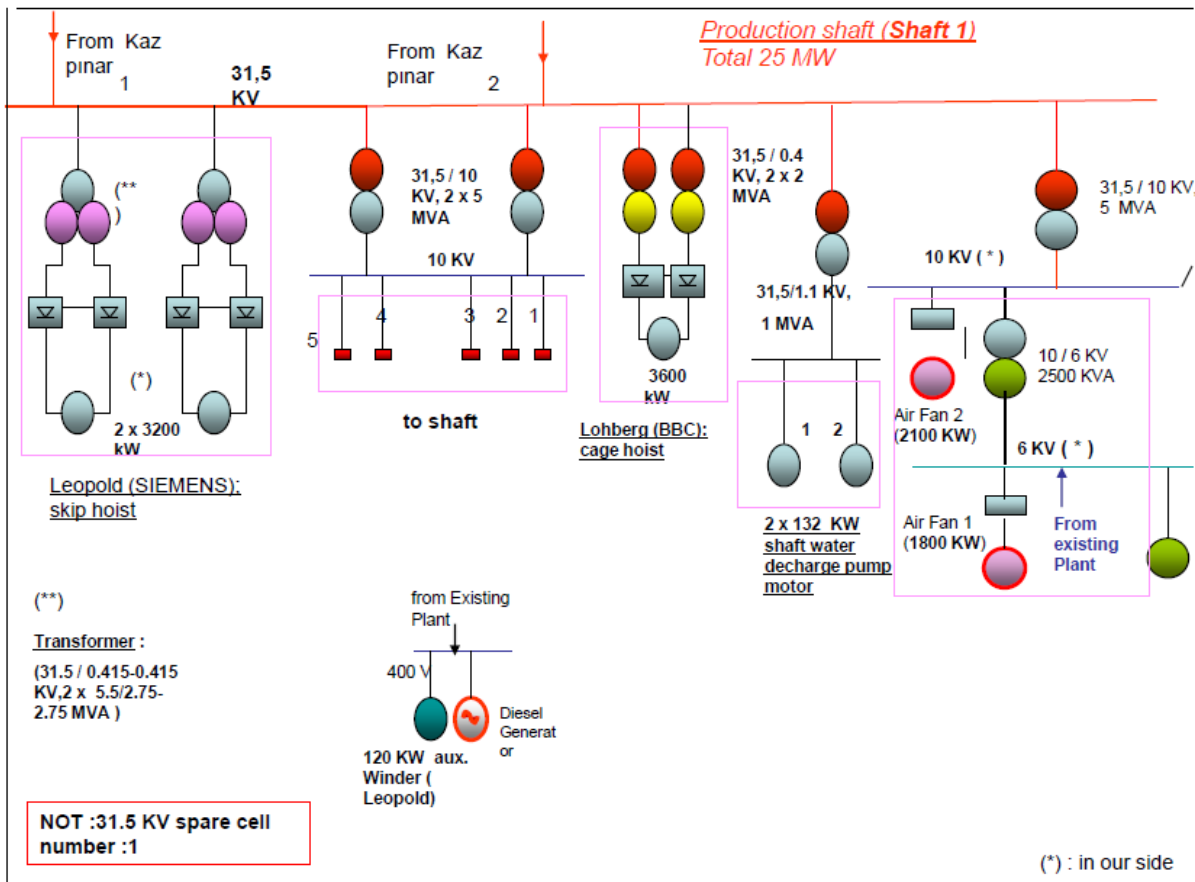

Figure 55. Shaft No.1 Power Diagram

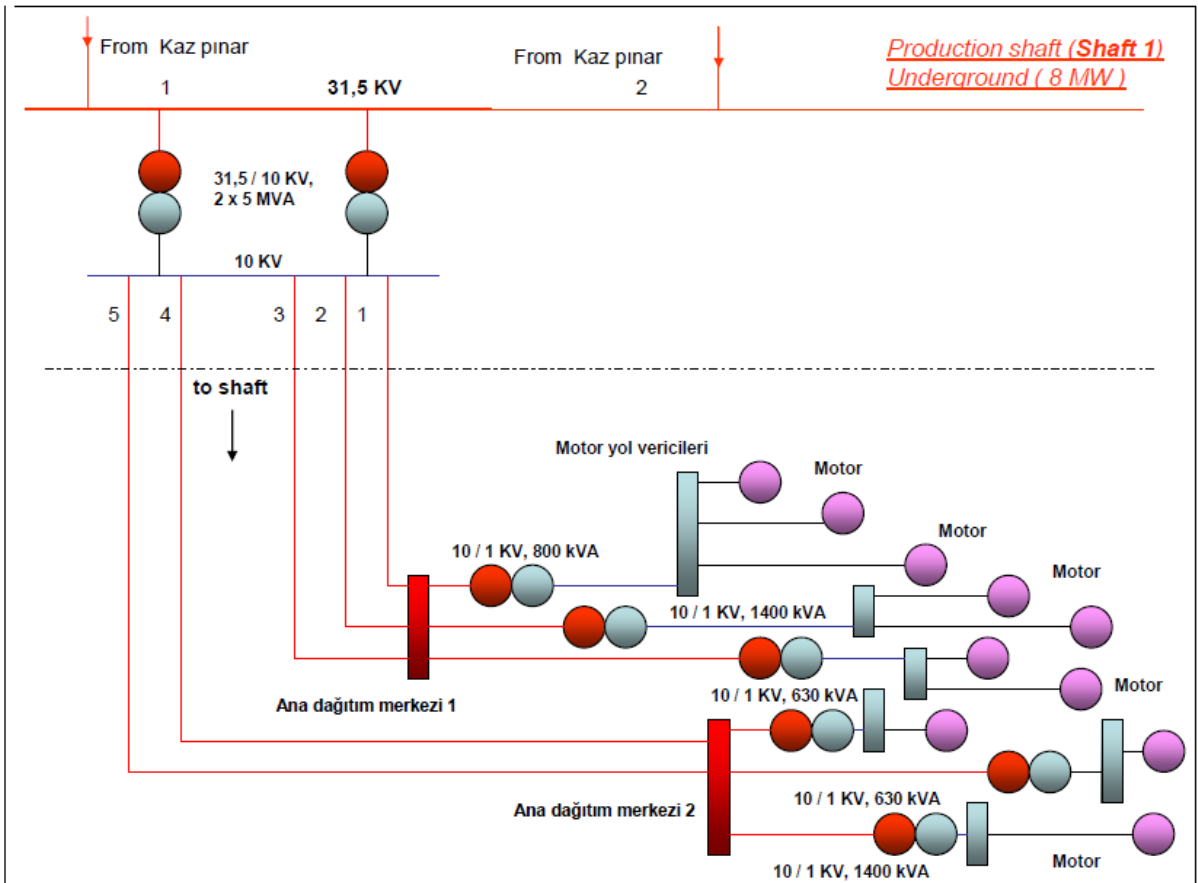

Figure 56. Shaft No.1 Underground Power Diagram

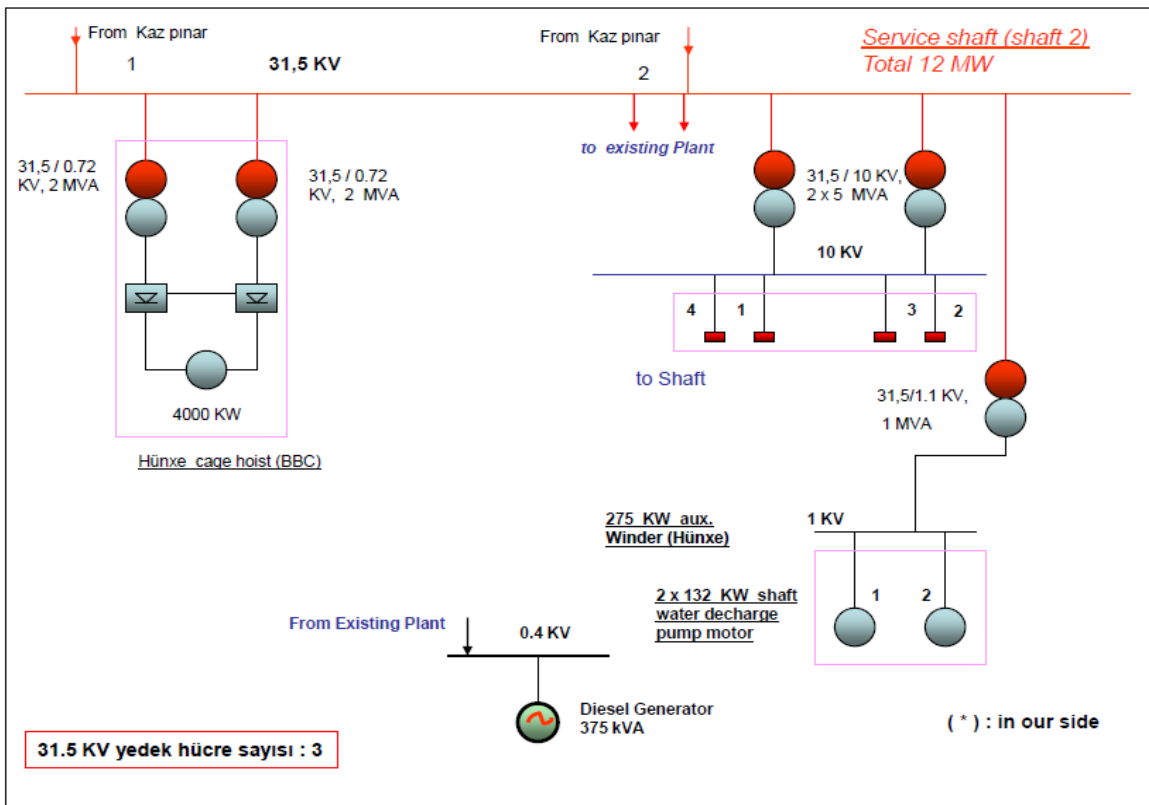

Figure 57. Shaft No.2 Power Diagram

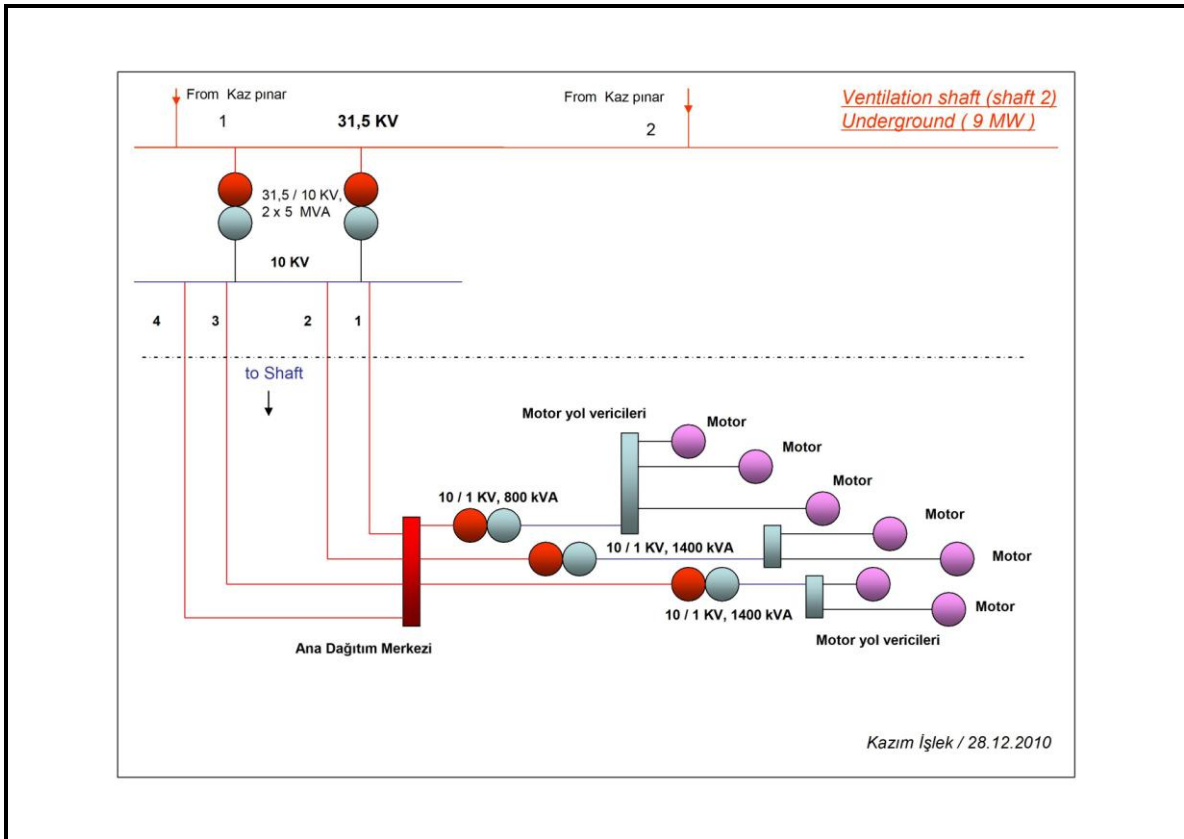

Figure 58. Shaft No.2 Underground Power Diagram

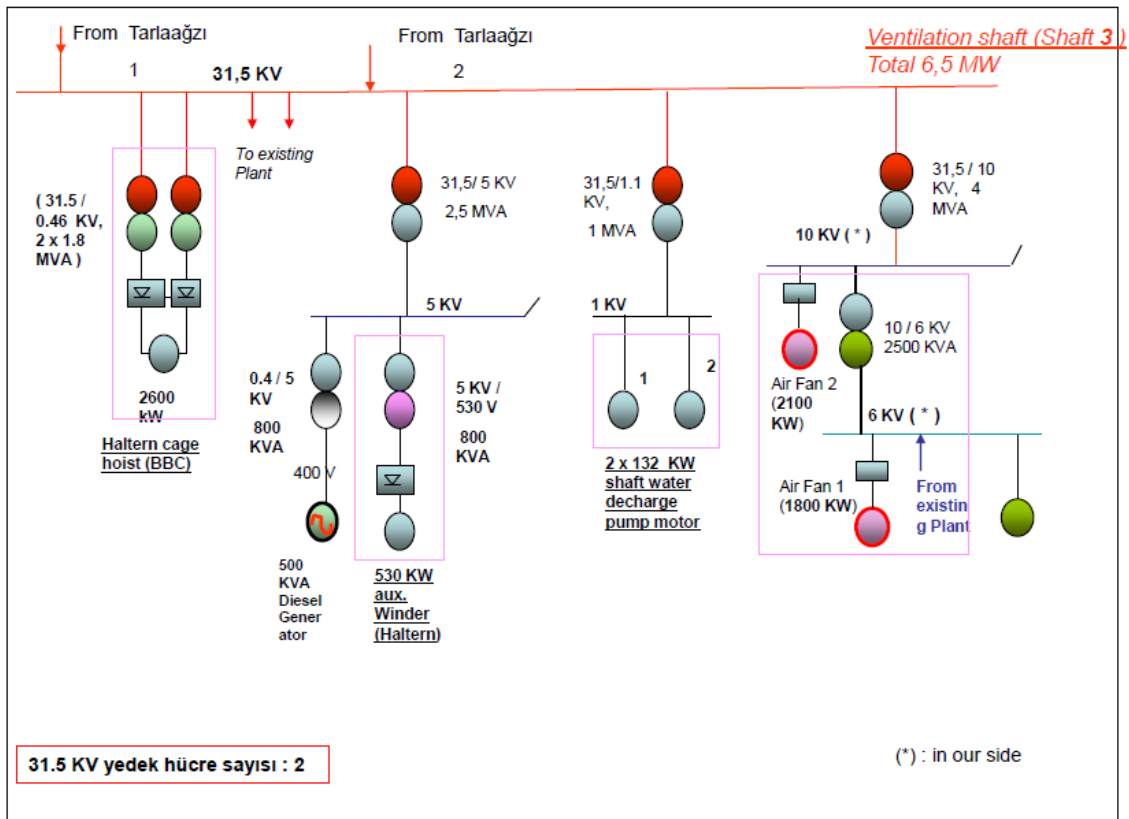

Figure 59. Shaft No.3 Power Diagram

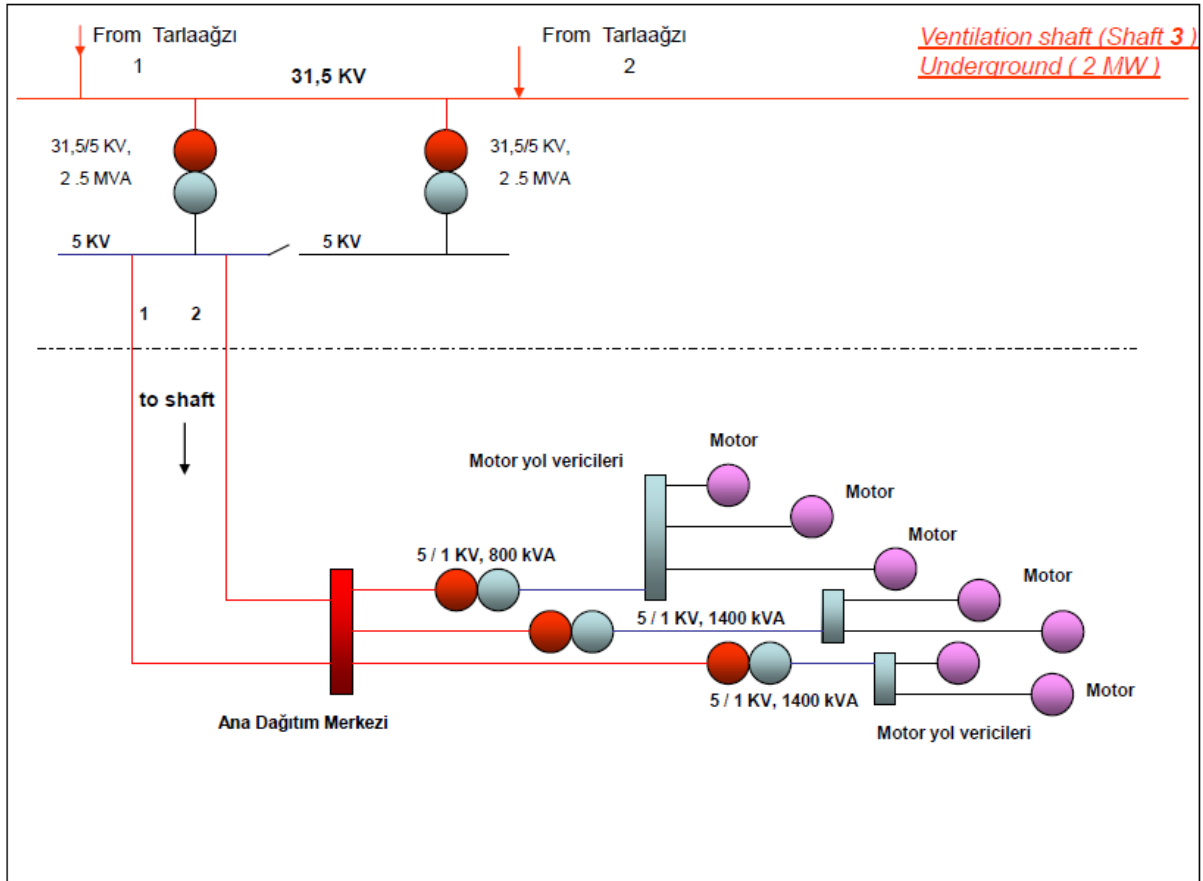

Figure 60. Shaft No.3 Underground Power Diagram

8.2. SURFACE FACILITIES

Surface facilities and detailed drawings of each utility, including treatment facility and dumping areas, of all three shafts are given in Appendix-42, Appendix-43 and Appendix-44. Timelines for construction of each facilities are given in Overall Timeline which is given as Appendix-51. Static calculations and detailed architectural drawings of surface facilities are given as an electronic copy.

9. ENVIRONMENTAL ASSESSMENT

9.1. LANDSCAPING

Keeping the dumping areas coherent to environment topography during and after works will be paid attention.

Agricultural soil, stored according to procedures, will be laid according to rehabilitation project given to Ministry of Forestry during authorization process. Lands authorized from Ministry of Forestry will be rehabbed suitable for forestration and will be delivered.

9.2. INDUSTRIAL WASTE WATER TREATMENT PLANT

For industrial waste water treatment, serial and multiple impoundments will be used. 250 m² areas will be required for impoundments. Purified water will be collected and fed back into the coal washing plant. Water consumption at underground activities is given in Table 44.

Table 44. Water Consumption At U/G Activities

	WORKING HOURS (min/day)	WORKING MACHINE NO (pcs)	CONSUMPTION OF MACHINERY (liter/min)	TOTAL CONSUMPTION OF MACHINERY (m ³)	PACK VOL. (m ³)	FACE NUMBER TO BE PACKED	TOTAL PACK VOL. (m ³)	TOTAL WATER CONSUMPTION AT PACKING AREAS (m ³)	GRAND TOTAL (m ³ /day)
Roadheader	540	3	50	81,0	-	-	-	-	81
Shearer Loader	360	3	140	151,2			-	-	151
Hydraulic Pumps	900	8	15	108,0			-	-	108
Jumbo driller, Electro-hydraulic loader	720	4	20	57,6					58
Gateway pack	-	-	-	-	59	3	177	45,0	45
U/G backfilling ash injection and methane drainage drillings	720	3	15	32,4	120	3	360	79,2	112
U/G belt conveyors	720	15	30	324,0	-	-		-	324
GRAND TOTAL									879

Usage of multiple impoundments is an advantage during the cleaning of the rejects at the bottom of impoundments, because the full impoundments will be cleaned up respectively and

the treatment facility will not be obstructed. The slime from coal washing plant will be sent to power plants.

The reject materials will be dumped into the dumping area.

For conservation of natural resources, research studies continue for optimization of water usage in coal washing plant and waste minimisation.

9.3. DOMESTIC WASTE WATER TREATMENT PLANT

Compact treatment system will be used for domestic wastewater treatment. The compact treatment plant treats waste water by a biologic system employing a microorganism community called activated sludge. As excess process sludge to be produced in the compact treatment unit is mineralized, it will be dewatered in sludge dewatering system, and the cake will be dumped into the dumping area of our facility. Total area requirement for treatment is ~150 m².

9.4. OTHER WASTES

Domestic solid wastes will be dumped into the dumping area of the municipality. Batteries, accumulators are being delivered to their producers. Waste oil, dangerous, hazardous, medical and other wastes are being handled according to the related regulations in Turkey.

9.5. DUMPING AREA PLANNING

The reject materials produced due to the coal extraction facilities, will be dumped into the dumping areas allowed by the local government in accordance with the topography of the surroundings. For the pH adjustment of the reject materials, they will be covered by subsoil and soil and used for re-vegetation on each bank. The topography of the facility areas will be brought into line with the surrounding areas in order to prevent accumulation of water. After rehabilitation of the field, forestation will be done with the endemic tree kinds. The necessary precautions will be taken to secure the workers and the facility.

10. EMPLOYMENT, LABOR PLANNING AND ORGANOGRAM

10.1. LABOR REQUIRMENT BY YEARS

Personnel are divided in two groups as underground-employee and non-underground-employee. Labor requirement by years is given in Table 47, Table 48, Table 49 and Table 50.

Table 45. Labor Plan of Full Mechanized Panel

Title	Shift 1	Shift 2	Shift 3	Shift 4	Total
Mine Chief	1	1	1	1	4
Shift boss	1	1	1	1	4
Panel foreman	1	1	1	1	4
Shearer loader machine operator	3	4	3	3	13
Mechanized support operator	4	5	4	4	17
AFC operator	3	6	3	3	15
Belt conveyer operator	3	5	3	3	14
Pump operator	2	3	2	2	9
Electric technician	3	4	3	3	13
Hydraulic prop operator	5	4	5	5	19
Other	5	3	5	5	18
Total	31	37	31	31	130

Table 46. Labor Plan of Developments

Title	Shift 1	Shift 2	Shift 3	Shift 4	Total
Mine Chief	-	-	1	-	1
Shift boss	1	1	1	1	4
Electric technician	1	2	1	1	5
Mechanical technician	1	2	1	1	5
Blast hole driller	2	-	2	2	6
Blaster	1	-	1	1	3
Packer	2	-	2	2	6
Coal transport responsible	3	-	3	3	9
Support responsible	2	4	2	2	10
Material responsible	6	-	6	6	18
Total	19	9	20	19	67

Table 47. Labor Plan of Yearly 1,5 Million Ton Production Out of 1 Full-Mechanized Panels (2014-2016)

No	Title	Personnel number	Total	Total*	Remarks
1	Mine director	1	1	1	
2	Production superintendent	1	1	1	
3	Electro-mechanic superintendent	1	1	1	
4	Chief engineer	3	3	4	
5	Engineer and technician	14	14	17	

6	Underground workers	Shift 1	Shift 2	Shift 3	Shift 4			6 teams floor and support repair works
	Production team	31	37	31	31	130	156	1 full mechanized face
	Development team	114	54	120	114	402	482	
7	Winch operator	2	1	2	4	9	11	
8	Switch operator	7	7	7	7	28	34	
9	Dam worker	3	3	3	3	12	14	
10	Pump operator	2	2	2	2	8	10	
11	Repair crew	7	7	7	7	28	34	
12	Safety supervisor	3	3	3	3	12	14	
13	Safety workers	4	4	4	4	16	19	
14	Dynamite storage responsible	2	2	2	2	8	10	
15	Surface production personnel	4	4	4	4	16	19	
16	Surface workshop personnel	6	6	6	6	24	29	
17	Surface auxiliary service personnel	5	5	5	5	20	24	
18	Surface coal washing plant personnel	6	6	6	6	24	29	
19	Methane drainage personnel	4	4	4	4	16	19	
20	Rail transportation personnel	3	3	2	4	12	14	
21	Other (office)				18	18	22	
	Sub-total					783	940	
	TOTAL					797	956	*20% Absenteeism

Table 48. Labor Plan of Yearly 2,5/3,0 Million Ton Production Out of 2 Full-Mechanized Panels (2017-2018)

Seri No	Title	Personnel number	Total	Total*	Remarks
1	Mine director	1	1	1	
2	Production superintendent	1	1	1	
3	Electro-mechanic superintendent	1	1	1	

4	Chief engineer	3				3	4	
5	Engineer and technician	12				12	14	
6	Underground workers	Shift 1	Shift 2	Shift 3	Shift 4			6 teams floor and support repair works
	Production team	62	74	62	62	260	312	2 full mechanized face
	Development team	114	54	120	114	402	482	
7	Winch operator	4	2	4	4	14	17	
8	Switch operator	15	15	15	15	60	72	
9	Dam worker	6	6	6	6	24	29	
10	Pump operator	6	6	6	6	24	29	
11	Repair crew	18	18	18	18	72	86	
12	Safety supervisor	5	5	5	5	20	24	
13	Safety workers	8	8	8	8	32	38	
14	Dynamite storage responsible	3	3	3	3	12	14	
15	Surface production personnel	15	15	15	15	60	72	
16	Surface workshop personnel	12	12	12	12	48	58	
17	Surface auxiliary service personnel	8	8	8	8	32	38	
18	Surface coal washing plant personnel	9	9	9	9	36	43	
19	Methane drainage personnel	8	8	8	8	32	38	
20	Rail transportation personnel	5	5	4	4	18	22	
21	Other (office)				18	18	22	
	Sub-total					1164	1397	
	TOTAL					1182	1418	*20% Absenteeism

Table 49. Labor Plan of Yearly 4,5 Million Ton Production Out of 3 Full-Mechanized Panels (2019-2025 & 2031-2037)

Seri No	Title	Personnel number				Total	Total*	Remarks
		Shift 1	Shift 2	Shift 3	Shift 4			
1	Mine director	1				1	1	
2	Production superintendent	1				1	1	
3	Electro-mechanic superintendent	1				1	1	
4	Chief engineer	3				3	4	
5	Engineer and technician	12				12	14	
6	Underground workers							8 teams floor and support repair works
	Production team	93	111	93	93	390	468	3 full mechanized face
	Development team	152	72	160	152	536	643	
7	Winch operator	4	2	4	4	14	17	
8	Switch operator	15	15	15	15	60	72	
9	Dam worker	6	6	6	6	24	29	
10	Pump operator	6	6	6	6	24	29	
11	Repair crew	18	18	18	18	72	86	
12	Safety supervisor	5	5	5	5	20	24	
13	Safety workers	8	8	8	8	32	38	
14	Dynamite storage responsible	3	3	3	3	12	14	
15	Surface production personnel	15	15	15	15	60	72	
16	Surface workshop personnel	12	12	12	12	48	58	
17	Surface auxiliary service personnel	10	10	10	10	40	48	
18	Surface coal washing plant personnel	9	9	9	9	36	43	
19	Methane drainage personnel	8	8	8	8	32	38	

20	Rail transportation personnel	5	5	4	4	18	22	
21	Other (office)				18	18	22	
	Sub-total					1436	1723	
	TOTAL					1454	1745	*20% Absenteeism

Table 50. Labor Plan of Yearly 5 Million Ton Production Out of 4 Full-Mechanized Panels (2026-2032)

Seri No	Title	Personnel number				Total	Total*	Remarks
1	Mine director	1				1	1	
2	Production superintendent	1				1	1	
3	Electro-mechanic superintendent	1				1	1	
4	Chief engineer	4				4	5	
5	Engineer and technician	14				14	17	
6	Underground workers	Shift 1	Shift 2	Shift 3	Shift 4			8 teams floor and support repair works
	Production team	124	148	124	124	520	624	4 full mechanized face
	Development team	152	72	160	152	536	643	
7	Winch operator	5	3	5	5	18	22	
8	Switch operator	20	20	20	20	80	96	
9	Dam worker	6	6	6	6	24	29	
10	Pump operator	9	9	9	9	36	43	
11	Repair crew	30	30	30	30	120	144	
12	Safety supervisor	5	5	5	5	20	24	
13	Safety workers	8	8	8	8	32	38	
14	Dynamite storage responsible	3	3	3	3	12	14	
15	Surface production personnel	24	24	24	24	96	115	
16	Surface workshop personnel	17	17	17	17	68	82	
17	Surface auxiliary service personnel	18	18	18	18	72	86	

18	Surface coal washing plant personnel	14	10	14	14	52	62	
19	Methane drainage personnel	12	12	12	12	48	58	
20	Rail transportation personnel	10	10	10	10	40	48	
21	Other (office)				20	20	24	
	Sub-total					1794	2153	
	TOTAL					1815	2178	*20% Absenteeism

New recruits hired from district will be trained at Kandilli Mine and in the training face, which will be installed in Amasra, in order to have workers ready when required. Moreover, theoretical and practical training courses by equipment manufacturer companies are being planned in order to train engineers and operators. Also, it is possible to benefit by electrical and mechanical technicians working in TTK. Thus, supplying personnel for the increasing demand will be no problem.

Required trainings for PRS, mechanical, hydraulic, electrical, cutter machines and transportation equipment are included in mechanized equipment procurement contract. Programs for training will be provided from companies.

10.2. ORGANOGRAM

Organogram of Amasra Project is given as Appendix-60.

11. INVESTMENTS, OPERATIONAL COSTS AND UNIT COSTS

11.1. INVESTMENTS

- Underground development works
- Surface construction works
- Electrical works
- Purchasing of equipment
- Installation works
- Surface coal washing plants and installations
- Methane drainage systems and installations
- Other necessary construction works to be performed until mine starts production

11.1.1. AMOUNT OF INVESTMENTS

Total investment is calculated to be € 733.524.873 and it includes the items given in Appendix-36.A.

11.1.2. INVESTMENT ITEMS

Investment plan of the project is given as Appendix-36.A. Annual investments of the project is given in Table 51.

Table 51. Annual Investments of HEMA Amasra Hardcoal Project

YEARS	PLANNED (€)	ACTUAL (€)	RATIO (%)
2005	2.000.000	233.134	11,66
2006	6.000.000	1.971.625	32,86
2007	10.000.000	9.418.644	94,19
2008	15.000.000	14.986.232	99,91
2009	15.000.000	9.676.003	64,51
2010	25.000.000	18.040.559	72,16
2011	25.000.000	20.326.856	81,31
2012	30.000.000	22.592.250	75,30
2013	55.000.000		
2014	120.000.000		
2015	85.000.000		
2016	25.000.000		
2017	35.000.000		
2018	30.000.000		
2019	30.000.000		
2020	15.000.000		
2021	10.000.000		

2022	10.000.000		
2023	10.000.000		
2024	20.000.000		
2025	20.000.000		
2026	35.000.000		
2027	35.000.000		
2028	12.000.000		
2029	10.000.000		
2030	7.000.000		
2031	7.000.000		
2032	7.000.000		
2033	4.000.000		
2034	4.000.000		
2035	4.000.000		
2036	4.000.000		
2037	4.000.000		
2038	2.000.000		
2039	2.000.000		
2040	1.000.000		
2041	1.000.000		
2042	1.000.000		
2043	524.873		
TOTAL	733.524.873	97.245.303	13,49

11.2. OPERATIONAL COSTS

The operational costs will be calculated on yearly basis starting from the production of first panel on April 2015. Operational costs are given under the following titles.

- Labor
- Energy and water
- Mine operation
- Consumables
- Services
- Washing plant's operational costs
- Environmental protection
- Loyalty, taxes, payments to the government and etc
- General administrative costs

Total operational costs will be **117.105.497 Euro** per year when full capacity production is realized.

11.2.1. LABOR

Table 52. Personnel Number Distribution of Amasra-B and Shallow Coals

Year	Personnel Number
2013	385
2014-2015	1182
2016	1294
2017	1983
2018	1846
2019	2020
2020	2240
2021	2048
2022	2223
2023	2433
2024	2080
2025	1593
2026-2031	1815
2032-2037	1454
2038	1050
2039-2042	1060
2043	1061

Personnel are divided into two subgroups as underground and surface. It is calculated that each underground and surface personnel will be paid 750Euro per month, averagely.

During full capacity production, yearly total labor cost will be **16.506.000 Euro**. Labor cost related to heading works is not included here since it is included in the investments.

11.2.2. ENERGY AND WATER

In Germany, 60kwh/ton energy is consumed by the underground mines. Yearly energy cost will be 42.000.000Euro over 14cent/kwh including system operational costs, funds and taxes. Cost of the water that is consumed in one year will be 750.000Euro (0.15 Euro/ton). Total cost will be 42.750.000 Euro/year.

11.2.3. HEADING WORKS IN THE SEAM

Operational cost of heading works in the seam covers all the related expenses such as labor, materials and consumables.

Averagely 140Euro/m cost is calculated for air duct, shotcrete, rock bolt, resin, wire mesh and various material for heading works in the seam during full capacity production. 0.15Euro/ton cost is calculated for detached belts during production, malfunctioned rollers and dynamos etc., 0.20Euro/ton cost is calculated for pilot drilling, methane drainage during production and developments, substituted parts of monorail, coolicar and for the fuel consumption and 0.10Euro/ton cost is calculated for concreting, wire mesh, bolting and injection at other production Blocks.

There will be 4 heading teams and their advance rate will be 90m/month and total annual cost of this title will be 4.210.000Euro.

11.2.4. CONSUMABLES

It is very difficult to calculate this cost since it requires very detailed studies. Costs related to timbers, steel, concrete, fuel, drill bits, wire-mesh, ropes, hoses and etc are all included in this title. For mechanized production cost of consumables is taken 5.00Euro/ton (average).

During full capacity production, this cost is calculated to be 25.000.000Euro per year.

11.2.5. MAINTANANCE SERVICES

During full capacity production, this cost will be 3.100.000 Euro per year, averagely 0.62Euro/ton.

11.2.6. OPERATIONAL COSTS OF WASHING PLANT

Petroleum, lubricant, spare part costs are 15% of the initial investment of coal washing plant that is to say 3.750.000Euro/year, which is 0,75Euro/ton. In addition to that, yearly 7,5kWh/ton energy consumption is estimated and energy cost is calculated to be 5.250.000Euro/year. In total, it will be 9.000.000 Euro/year.

11.2.7. DISPOSAL AREA AND LANDSCAPING

Costs related to transport of waste to the disposal area and rehabilitation of the disturbed areas are estimated to be 2.300.000Euro per year (0.46Euro/ton) during full capacity production.

11.2.8. GENERAL AND ADMINISTRATIVE COSTS

Administrative cost is estimated to be 3.250.000Euro/year (0.65Euro/ton).

11.2.9. ROYALTY

According to the agreement between TTK and HEMA, royalty is 7,15 TL/ton for R.O.M. coal. This figure is increased to 13.25 TL/ton based on Turkish Statistical Institute PPI Mining index of 01.01.2012 date. Based on the exchange rate in the date of 01.01.2012 (1Euro=2.20TL), price of one ton of coal is calculated to be 6,02Euro. If 5 million ton production is assumed than totally 30.100.000Euro is added to the operational costs.

11.2.10. AMORTIZATION

While the total investment is being 720.546.712 Euro, after reducing the 25% scrap portion, 540.410.034Euro will be added to the operational costs as investments amortization. 35.435.673 Euro/year is added to the operational costs by taking the amortization period as 15 years.

11.2.11. DYNAMITE & DETONATORS

Unit price of the explosives is 1,43Euro/kg. Therefore 1.404.400Euro is added to the operational costs for explosives. 1.200.000 unit detonator will be consumed and 1.100.000Euro for detonators. Unit price of the detonators is 1,13Euro/kg. Therefore 1.356.000Euro is added to the operational costs for detonators.

11.2.12. SOCIAL SECURITY PAYMENTS AND COMPENSATIONS

8% of the labor cost is the expenses that are to be paid by employer as compensation. Therefore, 1.440.000 Euro/year will be added to the operational cost.

Table 53. Investment and Operational Costs per Year (Amasra-B & Shallow Coals)

YEARS	PLANNED INVESTMENT (€)	ACTUAL (€)	RATIO (%)	PLANNED OPERATIONAL COSTS (€)
2005	2.000.000	233.134	11,66	
2006	6.000.000	1.971.625	32,86	
2007	10.000.000	9.418.644	94,19	
2008	15.000.000	14.986.232	99,91	
2009	15.000.000	9.676.003	64,51	
2010	25.000.000	18.040.559	72,16	
2011	25.000.000	20.326.856	81,31	
2012	30.000.000	22.592.250	75,30	
2013	55.000.000			4.879.720
2014	120.000.000			39.623.324
2015	85.000.000			86.658.720
2016	25.000.000			117.766.242
2017	35.000.000			126.041.642
2018	30.000.000			127.447.045
2019	30.000.000			169.981.949
2020	15.000.000			161.208.806
2021	10.000.000			181.432.216
2022	10.000.000			175.068.087
2023	10.000.000			168.090.579
2024	20.000.000			159.119.382
2025	20.000.000			146.365.586
2026	35.000.000			143.046.090
2027	35.000.000			146.197.670
2028	12.000.000			163.839.486
2029	10.000.000			163.299.369
2030	7.000.000			129.084.231
2031	7.000.000			122.039.717
2032	7.000.000			121.450.243
2033	4.000.000			114.993.033
2034	4.000.000			138.774.794
2035	4.000.000			127.810.537
2036	4.000.000			70.101.031
2037	4.000.000			66.081.051
2038	2.000.000			62.282.920
2039	2.000.000			60.172.981
2040	1.000.000			52.168.146

2041	1.000.000			58.574.439
2042	1.000.000			58.683.628
2043	524.873			42.016.157
TOTAL	733.524.873	97.245.303	13,49	3.504.298.82

Details of the annual operational costs are given in the Appendix-36.B.

11.3. ASSUMPTIONS OF COST CALCULATION

- Exchange rate: 1Euro=2.1 TL
- Construction costs are calculated by considering the local expenses.
- Heading costs are calculated by considering the local expenses.
- Timeline of the project consists of three periods which are development period (2005-2014), pre-production period (2015-2018) and production period (2018-2043).
- Operational costs that belong to the years of development period (2005, 2006, 2007, 2008, 2009, 2010, 2011, 2012 and 2013, 2014) are included in the investments. Financial expenses are excluded.
- Costs are calculated based on real time, inflation and escalation adjustments have not been considered. Discounted cash flow method is used for investment assessment and reduction ratio has been taken as 10%.
- Production efficiency is calculated to be 6,68 ton/man-wage. Production tonnages given in the Table 54 are considered.

Table 54. Annual Production Tonnages of Amasra-B and Shallow Coals

YEARS	PRODUCTION (Ton)
2013	4.880
2014	202.404
2015	985.901
2016	2.597.343
2017	3.084.887
2018	3.216.973
2019	4.992.039
2020	4.686.566
2021	5.512.110
2022	5.110.549
2023	4.995.472
2024	4.915.149
2025	4.401.105
2026	4.017.619
2027	4.169.365
2028	4.986.475
2029	5.011.140
2030	5.069.658
2031	4.741.222
2032	4.901.182
2033	4.616.249
2034	5.767.906
2035	5.256.545

2036	2.472.631
2037	2.264.409
2038	2.320.929
2039	2.219.752
2040	1.828.991
2041	2.159.150
2042	2.182.733
2043	1.253.015
TOTAL	109.944.349

11.4. COST ESTIMATIONS

Project cost is divided into two parts which are investments and operational costs. Financial cost is not considered at this stage. The aim is to show the profitability of the project by giving the production cost per ton of coal, internal rate of return and net present value figures.

Production cost consists of investments and operational costs. The fact that, project has a long lifetime, changes in the amount of the costs at different times and income flow should be taken into consideration.

List of the necessary components of the project valuation

- Table of investments
- Table of operational costs
- Cash flow is considered when calculating production cost, internal rate of return and net present value

Processed coal will be supplied as different products by different washing density adjustments based on market demands. Different washing processes were prepared based on various ash and calorific values and grain sizes for different demands of market. Ave. 26,01 material will be discarded by prepared washing processes. R.O.M. coal will be beneficiated by washing system with 1.55ton/m³ density and 0-10mm size. After washing, concentrate having 6000±200 kcal/kg lower calorific value and 18,50% ash will be produced. Saleable production and revenue are shown on sales table and cost table of Appendix-36.

Turkey imports 25 million ton coal per year to supply coking coal need of iron-steel industry, steam coal need of power plants and as fuel. Therefore, marketing the coal will be no problem.

To determine unit price of coal, the figures of TTK Amasra Hardcoal Mine (ATİ) and Hema Kandilli Colliery figures are taken into consideration.

By taking into consideration cash flow table, subtotals of the investments and operational costs at each year, then, at the peak level of production, year 2034 is considered, 5.767.906 ton of R.O.M. will be washed and 4.224.731 ton of coal will be products with different grain sizes, ash content and calorific values for market.

YEARLY;

Incomes	4.224.731 x 83,05 Euro/ton (ave.)	= 350.856.942 Euro/year
Costs	(330.185.092 TL/year)	= 138.774.794 Euro/year
Difference (revenue before tax)		+212.082.148 Euro/year

In the feasibility report prepared for mine investment, the revenue before tax will be 190.897.393 Euro/ton by taking the reduction ratio as 10%.

If net present value is calculated by taking the average coal sale price 83,05 Euro/ton, then it becomes $74,75 \times 4.224.731 = \mathbf{315.777.518 \text{ Euro}}$ Euro/year with 10% reduction. Coal production cost is 32,85 Euro/ton considering 138.774.794 Euro annual costs. By substituting this figure, then the revenue will be 41,90 Euro/ton. Therefore, Internal Rate of Return of the project will be **50,45%** at 5.767.906 ton rom production level.

OVER THE ENTIRE PROJECT;

Incomes	81.391.521 x 83,11 Euro/ton (ave.)	= 6.764.098.306 Euro
Costs		= 3.504.298.823 Euro
Difference (revenue before tax)		+3.259.799.483 Euro

In the feasibility report prepared for mine investment, the revenue before tax will be **+2.933.819.535 Euro** by taking the reduction ratio as 10%.

If net present value is calculated by taking the average coal sale price 83,11 Euro/ton, then it becomes $74,79 \text{ Euro/ton} \times 81.391.521 \text{ ton} = \mathbf{6.087.271.856 \text{ Euro income}}$ with 10% reduction. Coal production cost considering expenses is 43,14 Euro/ton with 31,65 Euro/ton profit. Internal Rate of Return of the project becomes **38,08%**.